

862F90" 8925EE60

APPROVED	O.G. FIG.	
BY	CLASS	SUBCLASS
DRAFTSMAN		

1/47

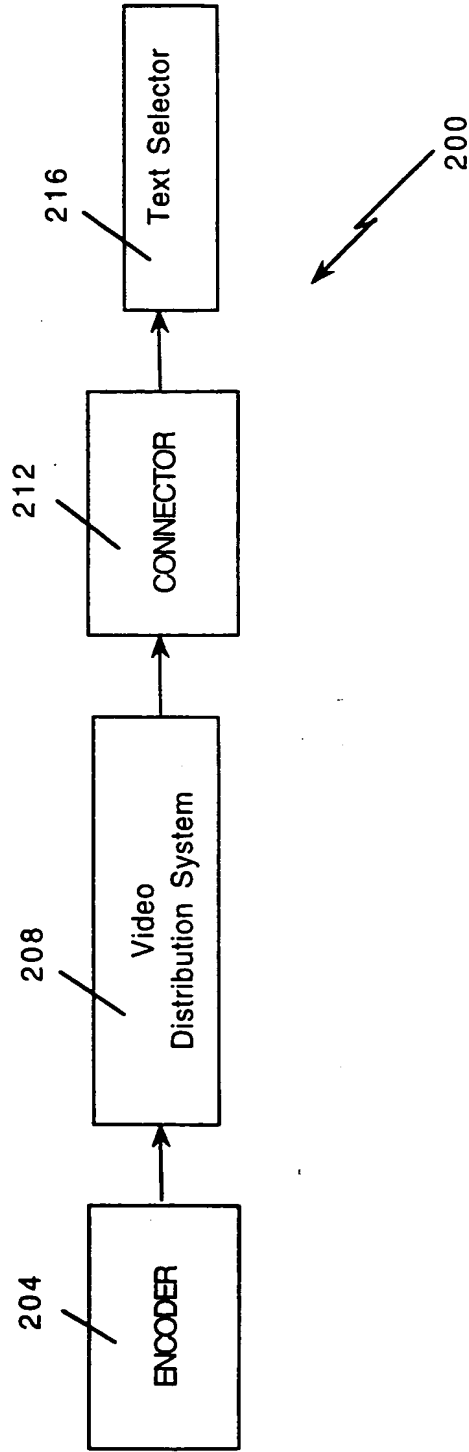

Fig. 1

APPROVED	O.G. FIG.	
BY	CLASS	SUBCLASS
DRAFTSMAN		

664790-8925660

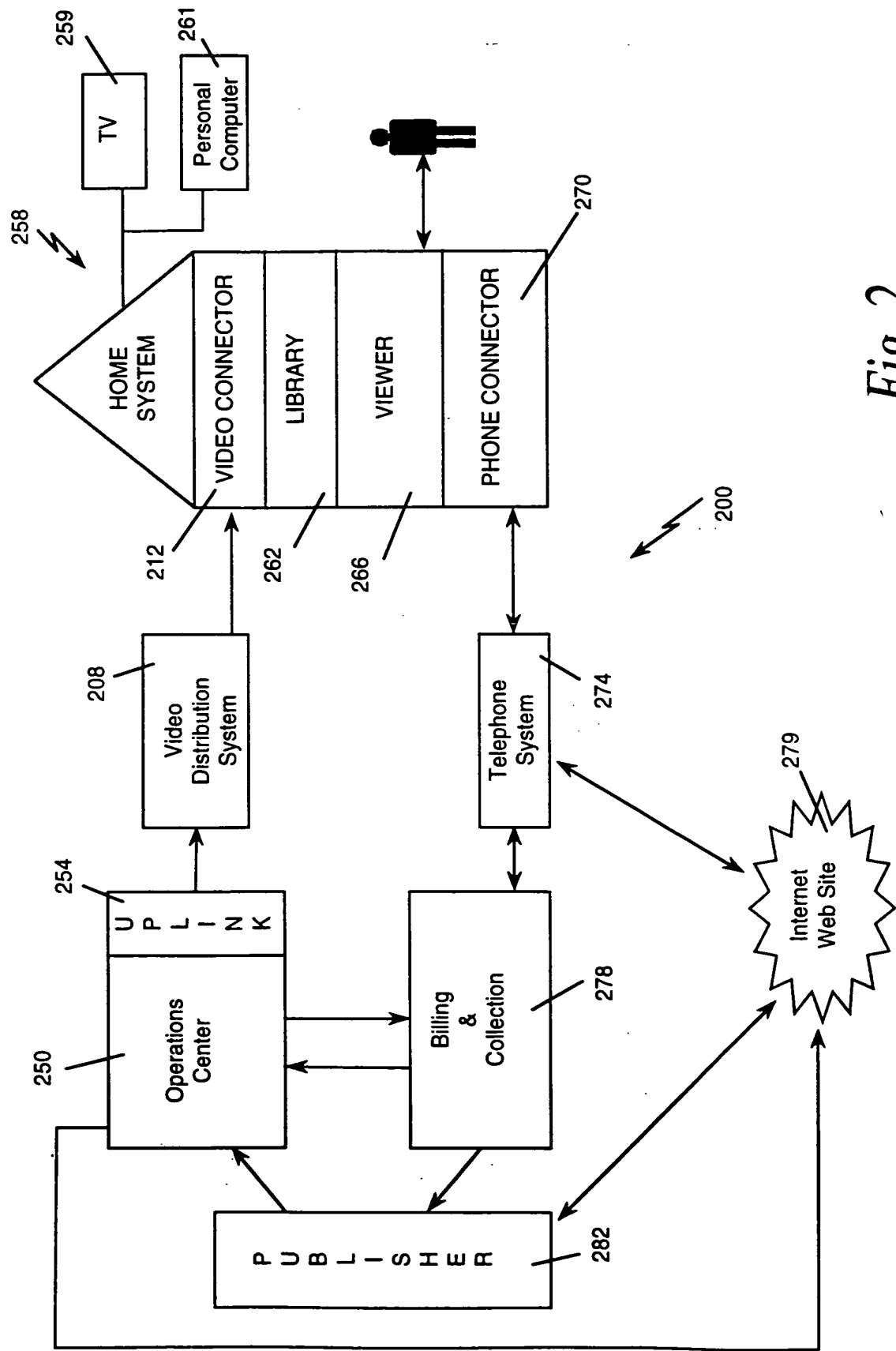

Fig. 2

APPROVED	O.G. FIG.	
BY	CLASS	SUBCLASS
DRAFTSMAN		

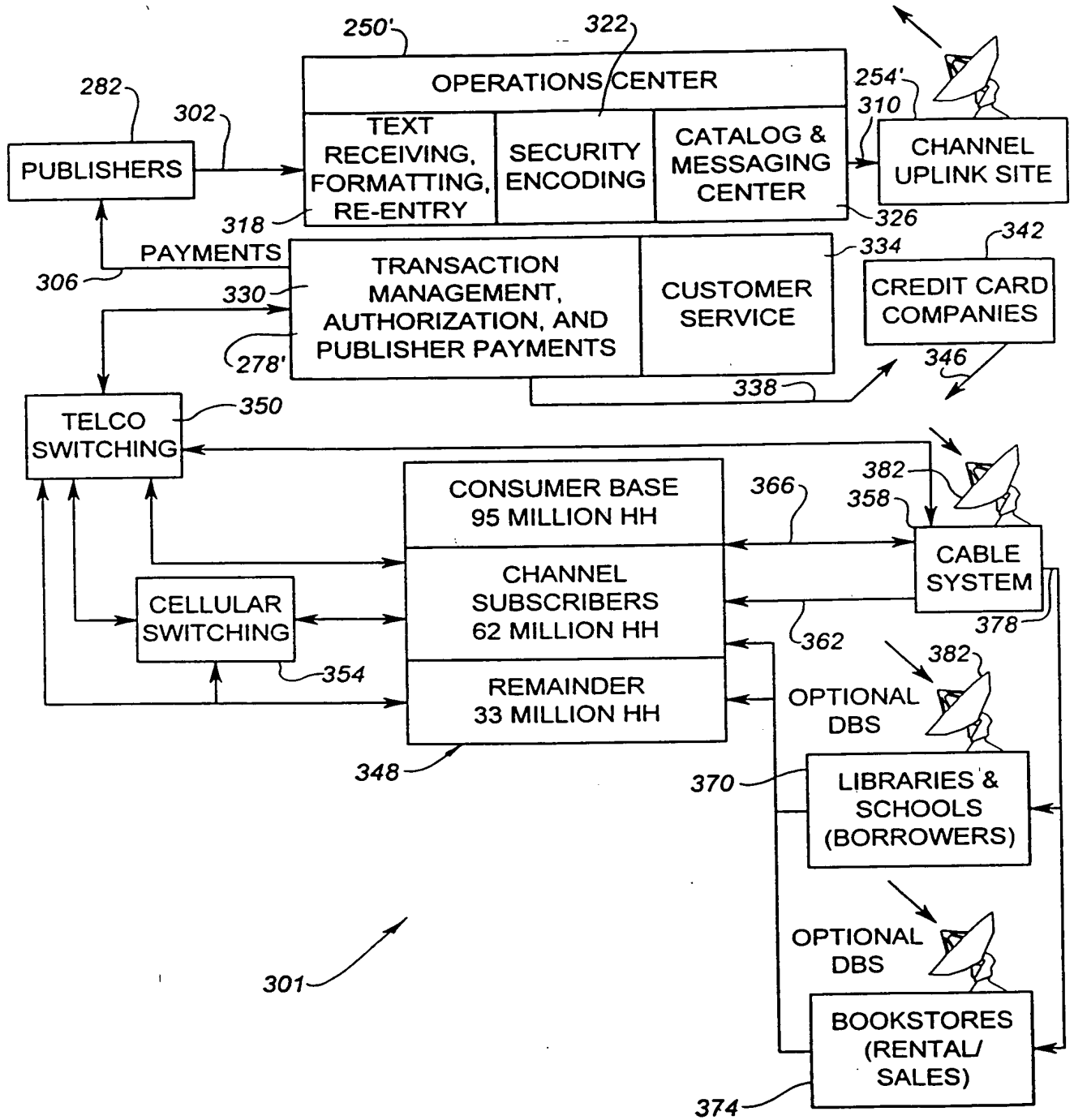

Fig. 3a

APPROVED	O.G. FIG.	
BY	CLASS	SUBCLASS
DRAFTSMAN		

66790-895560

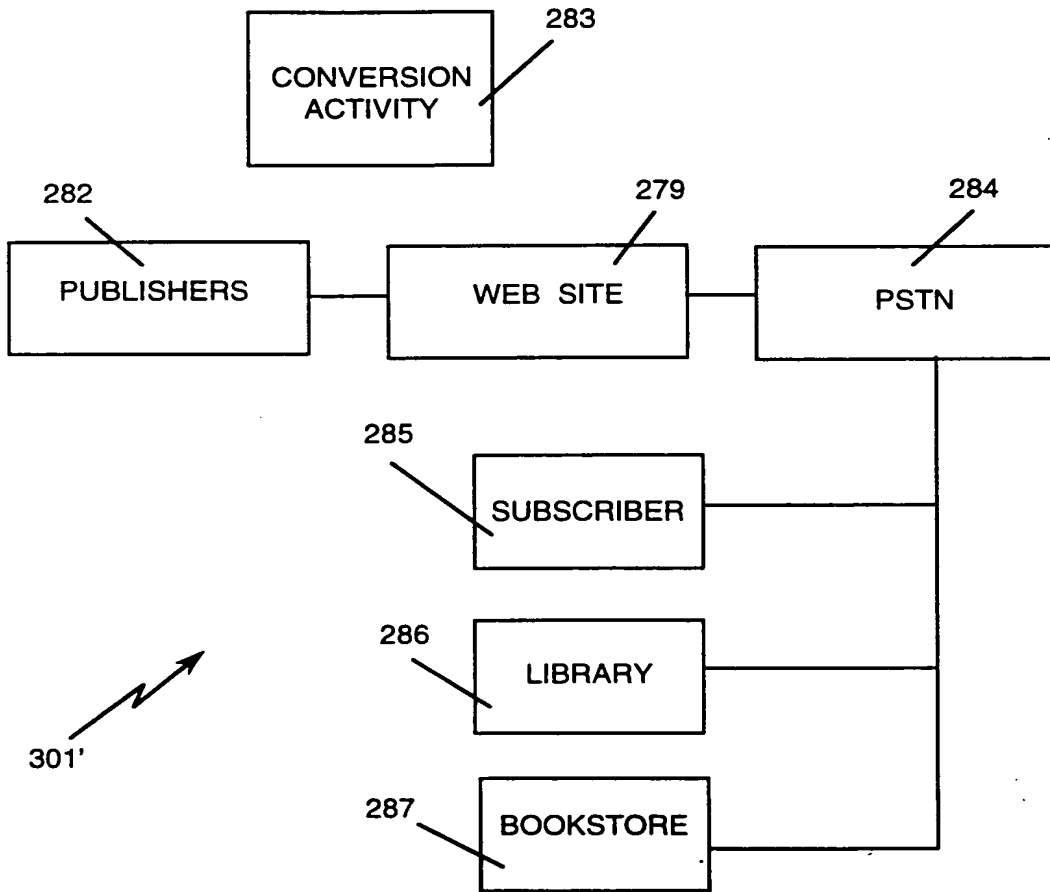

Fig. 3b

APPROVED	O.G. FIG.	
BY	CLASS	SUBCLASS
DRAFTSMAN		

664790-8929E50

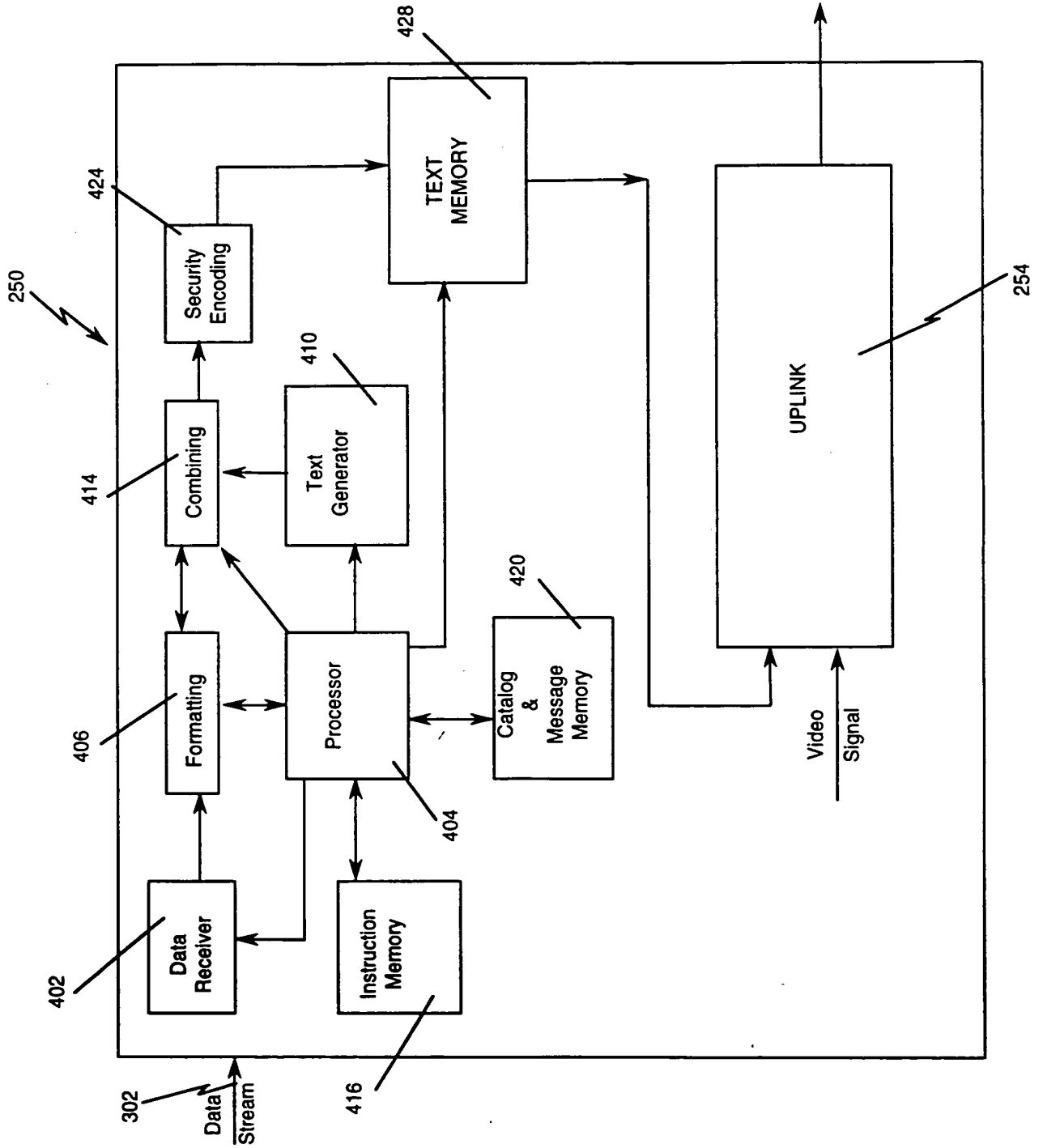

Fig. 4

APPROVED	O.G. FIG.	
BY	CLASS	SUBCLASS
DRAFTSMAN		

6162790-8925560

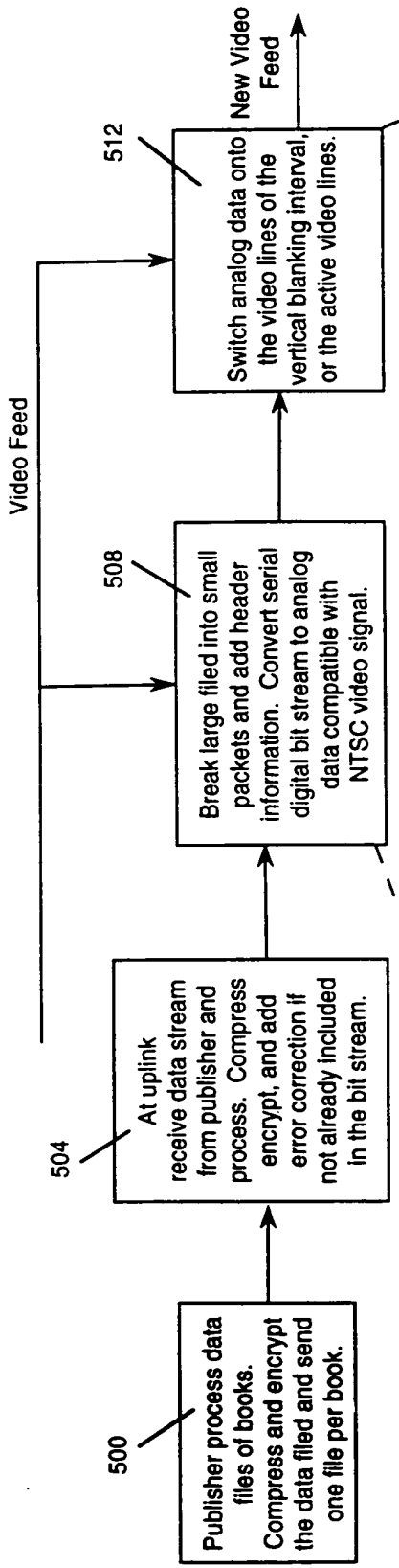

Fig. 5a

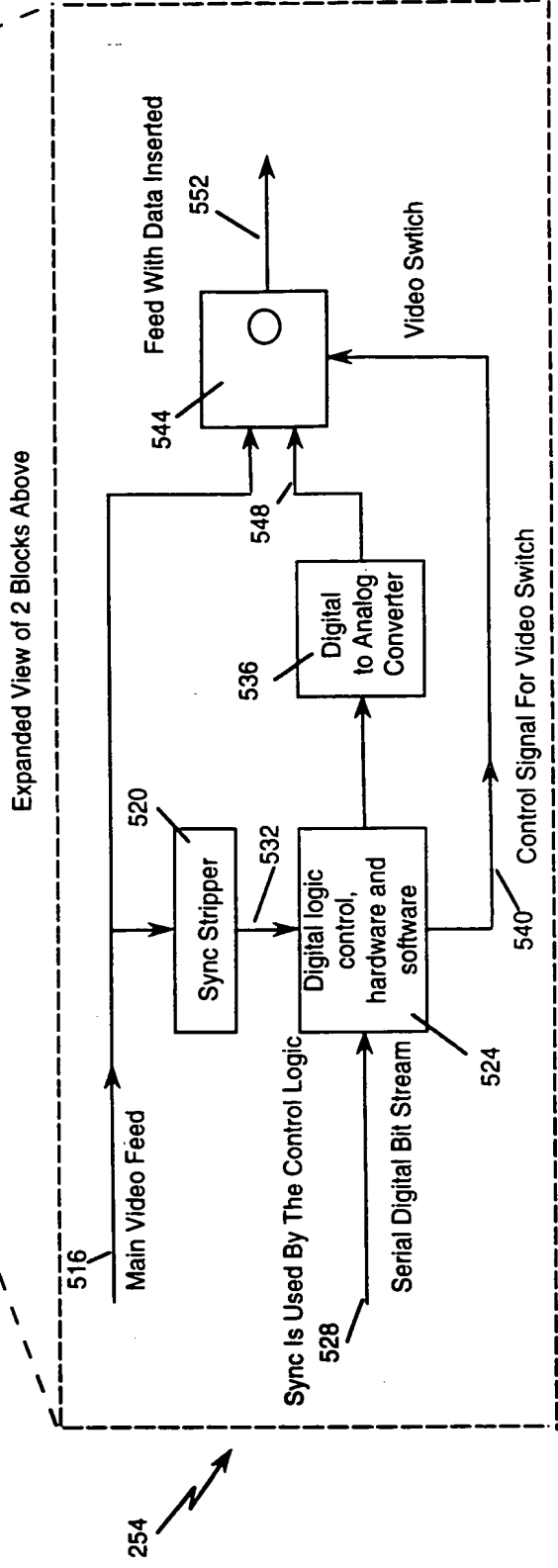

Fig. 5b

APPROVED	O.G. FIG.	
BY	CLASS	SUBCLASS
DRAFTSMAN		

562790" 8925EE60

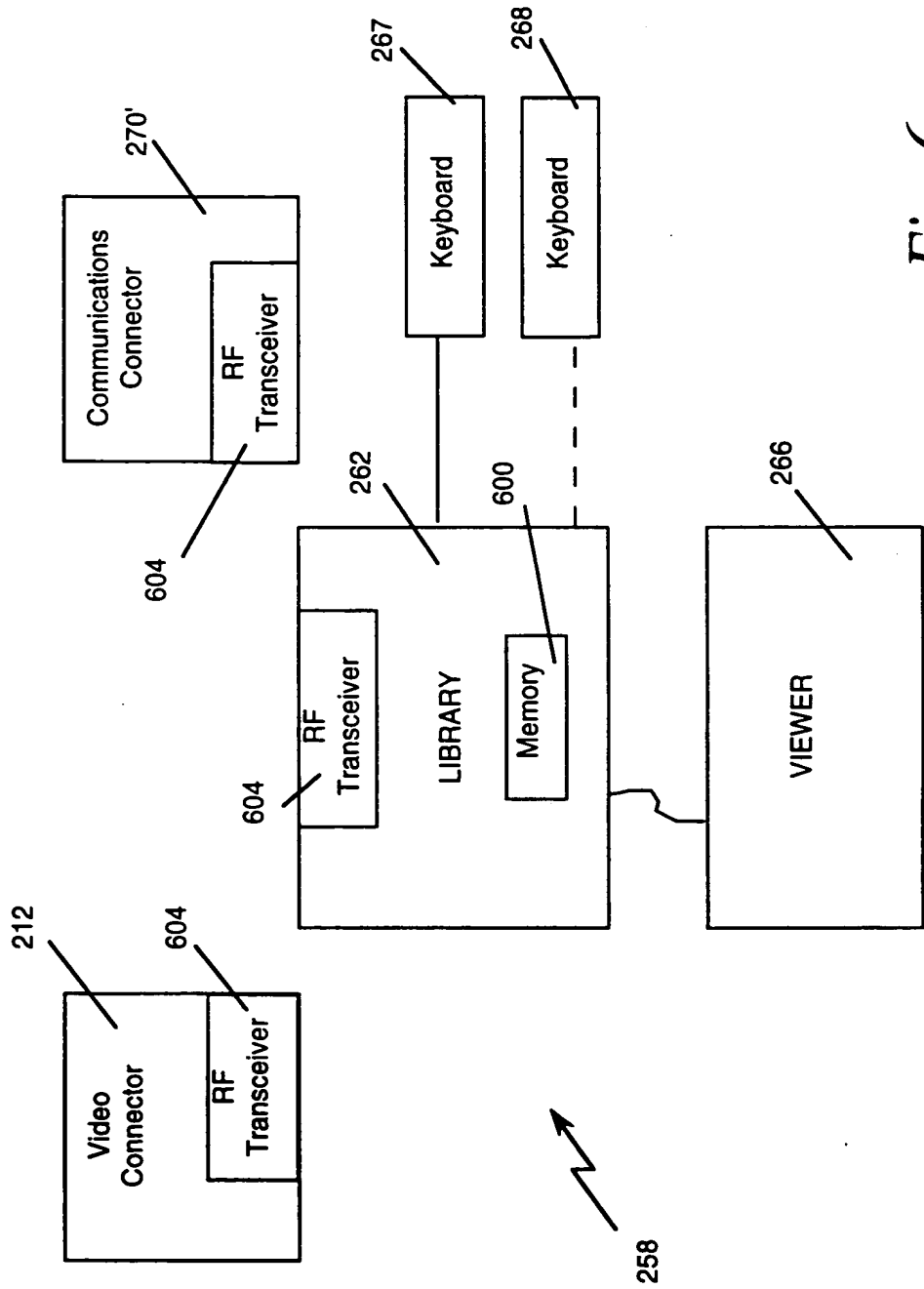

Fig. 6a

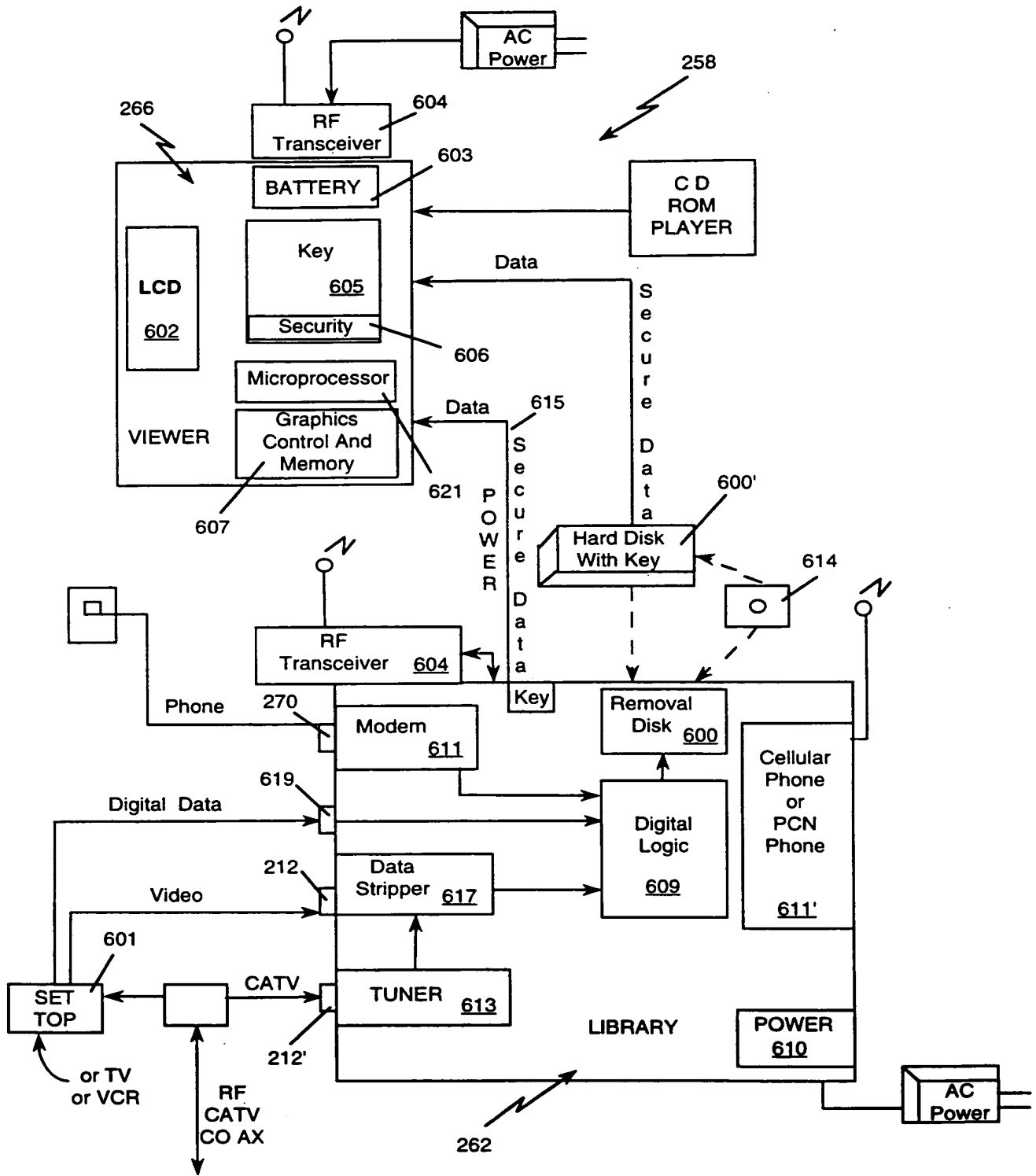

Fig. 6b

09335268 061799

APPROVED	O.G. FIG.	
BY	CLASS	SUBCLASS
DRAFTSMAN		

093555-06199
00790"8925E60

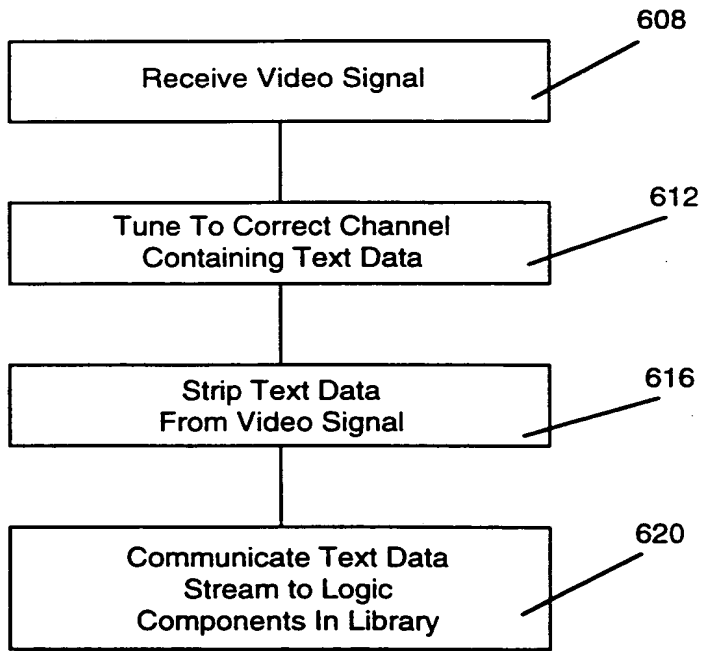
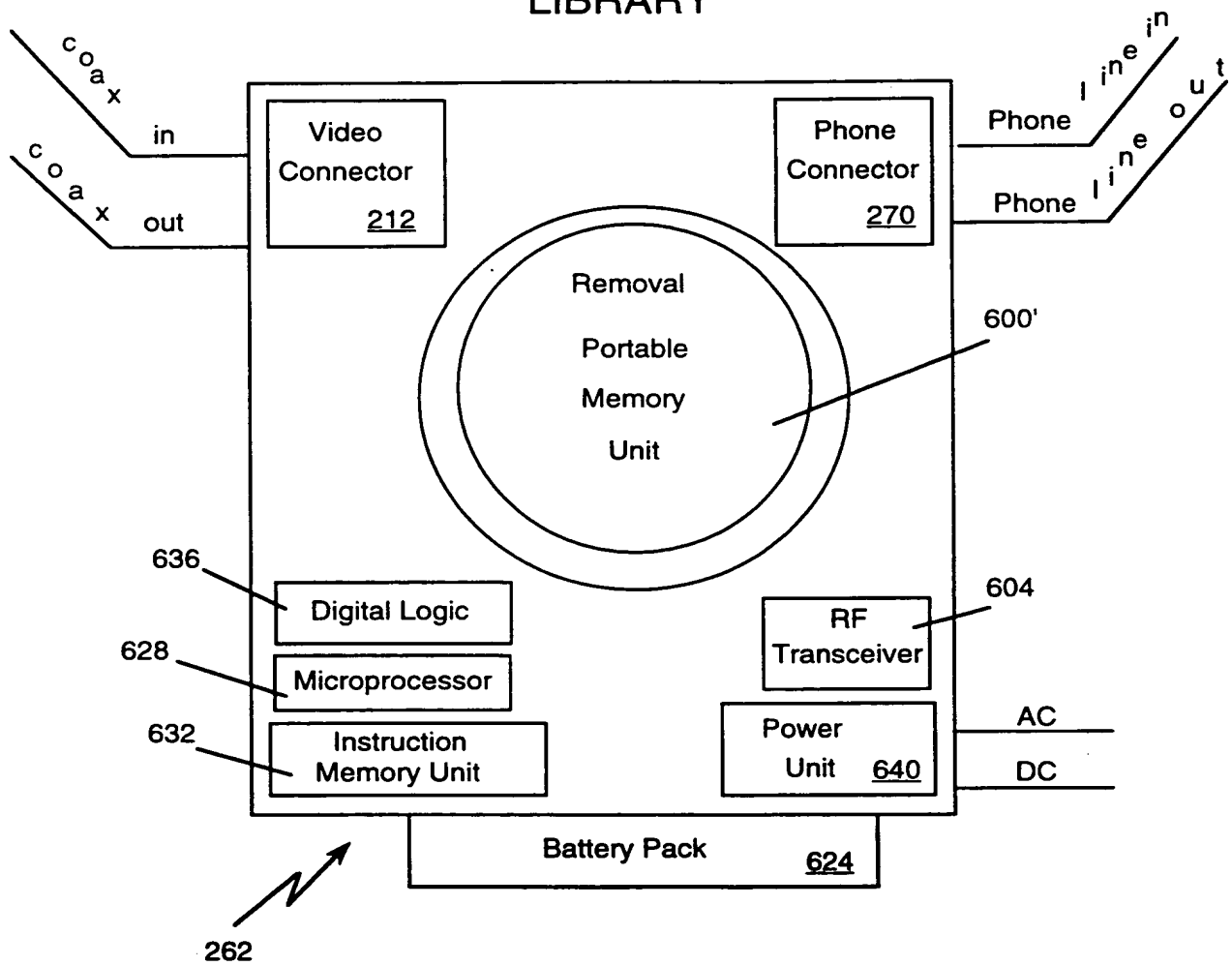

Fig. 7

APPROVED	O.G. FIG.	
BY	CLASS	SUBCLASS
DRAFTSMAN		

LIBRARY



662790" 89252E60

Fig. 8

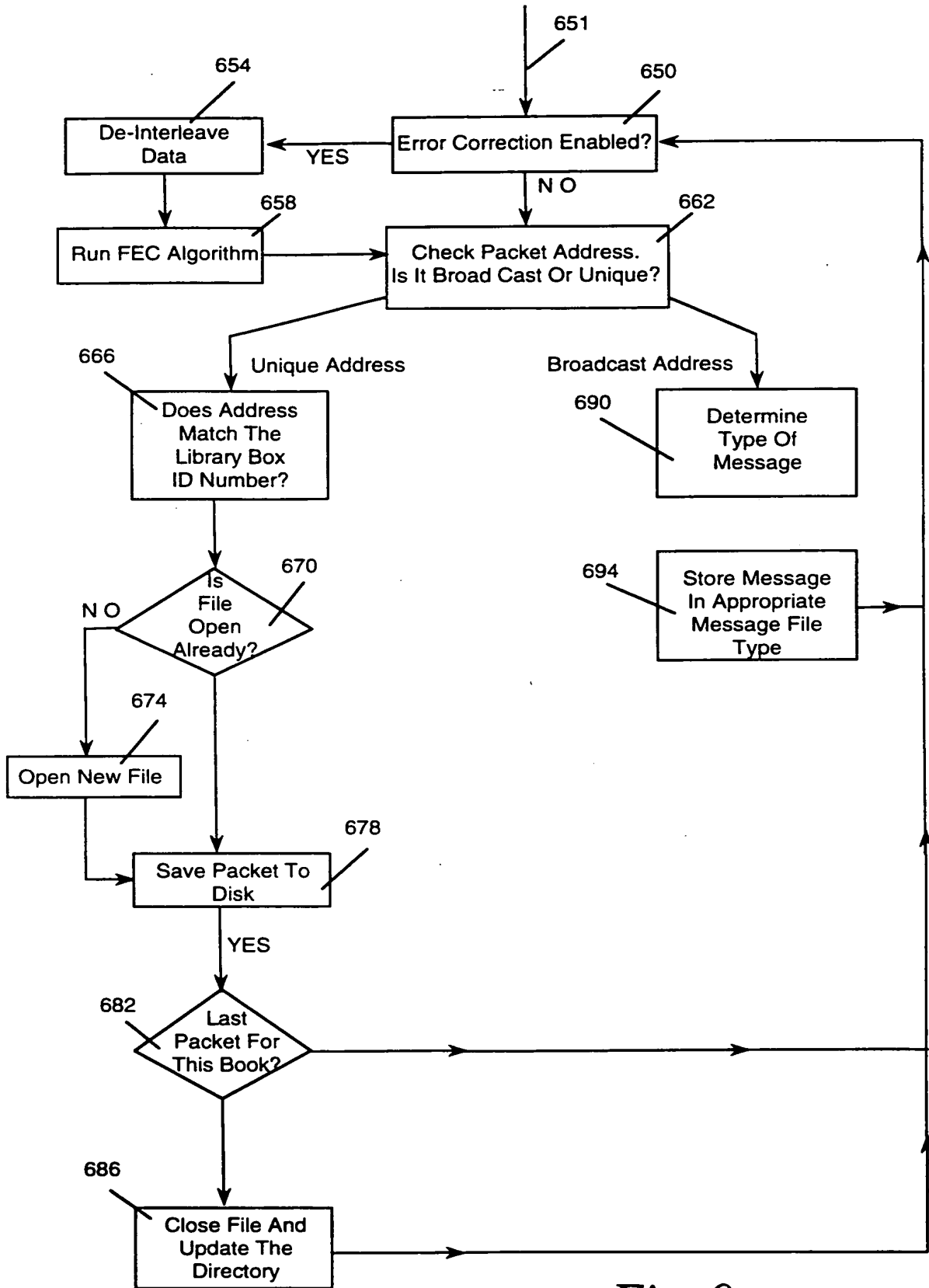

Fig. 9

662790" 8925660

APPROVED	O.G. FIG.	
BY	CLASS	SUBCLASS
DRAFTSMAN		

09335268-061799

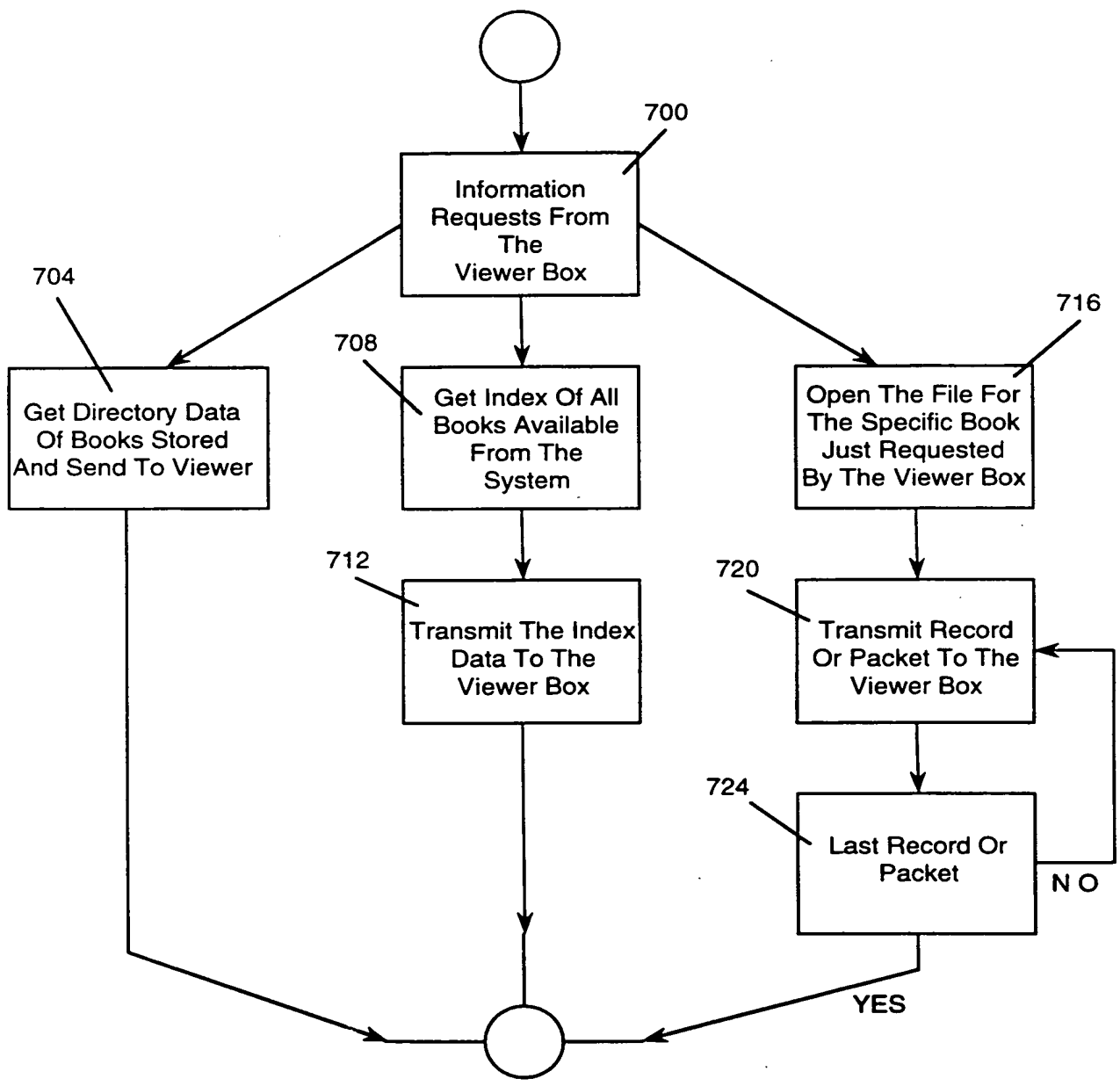

Fig. 10

APPROVED	O.G. FIG.	
BY	CLASS	SUBCLASS
DRAFTSMAN		

09222222 09222222

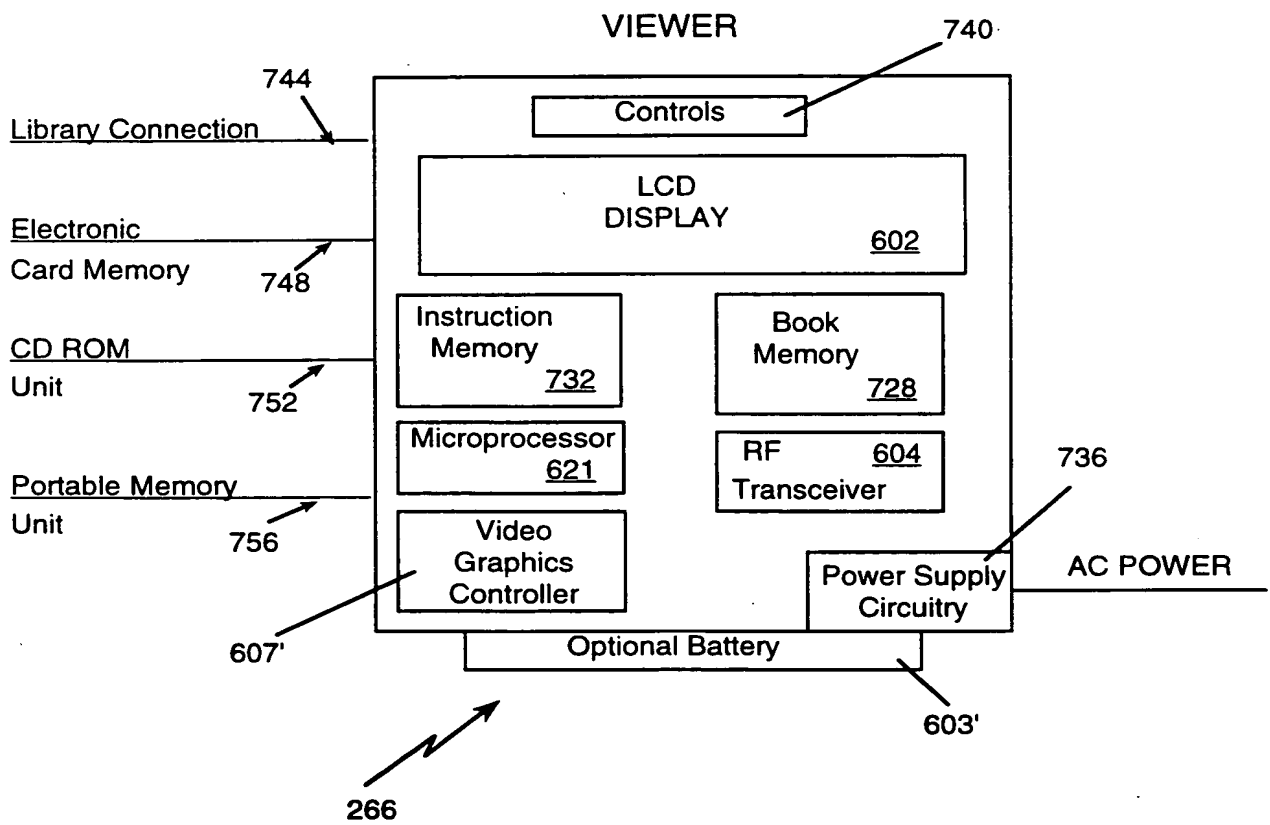

Fig. 11

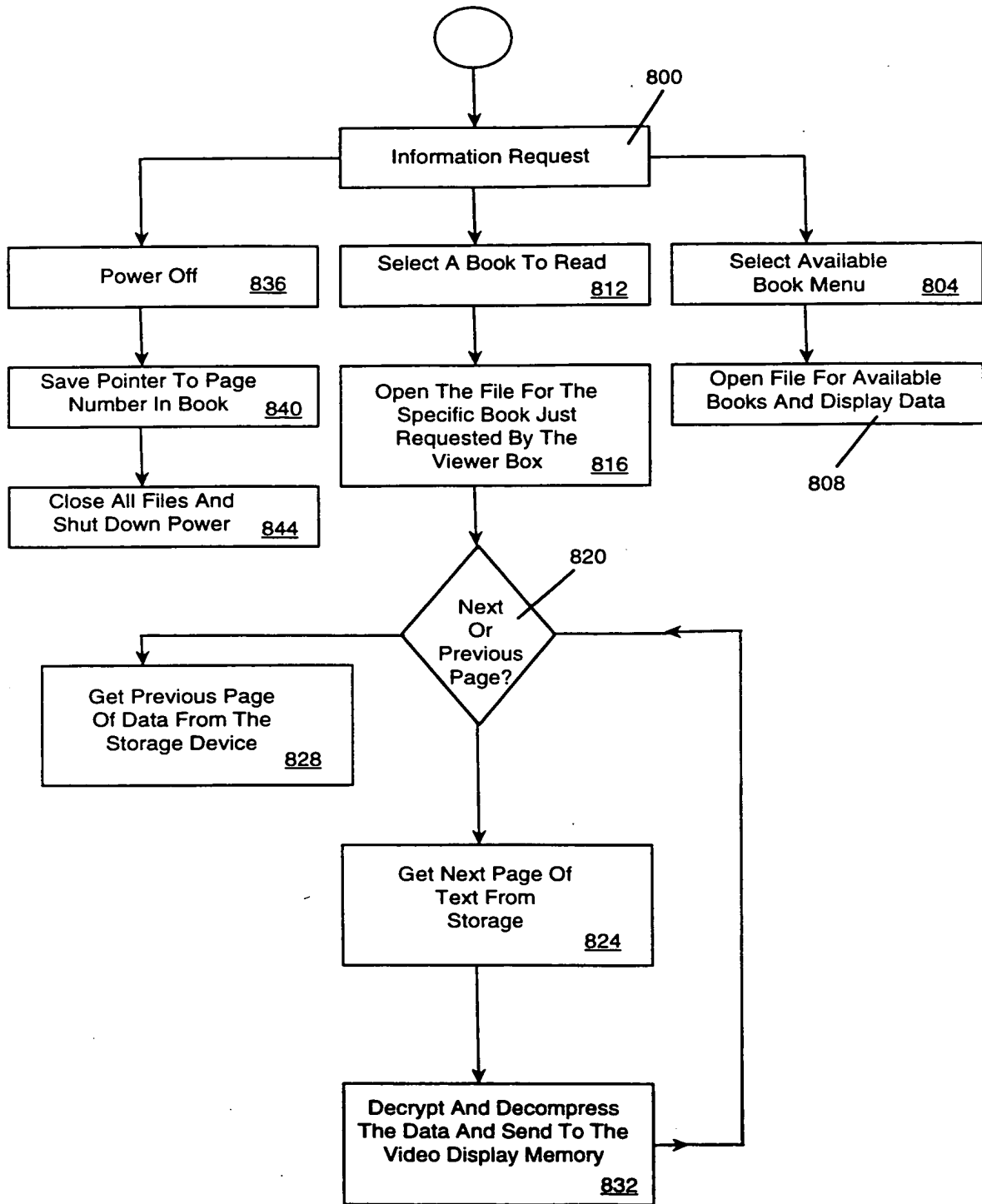

Fig. 12

662790" 89255560

APPROVED	D.G. FIG.	
BY	CLASS	SUBCLASS
DRAFTSMAN		

093325660

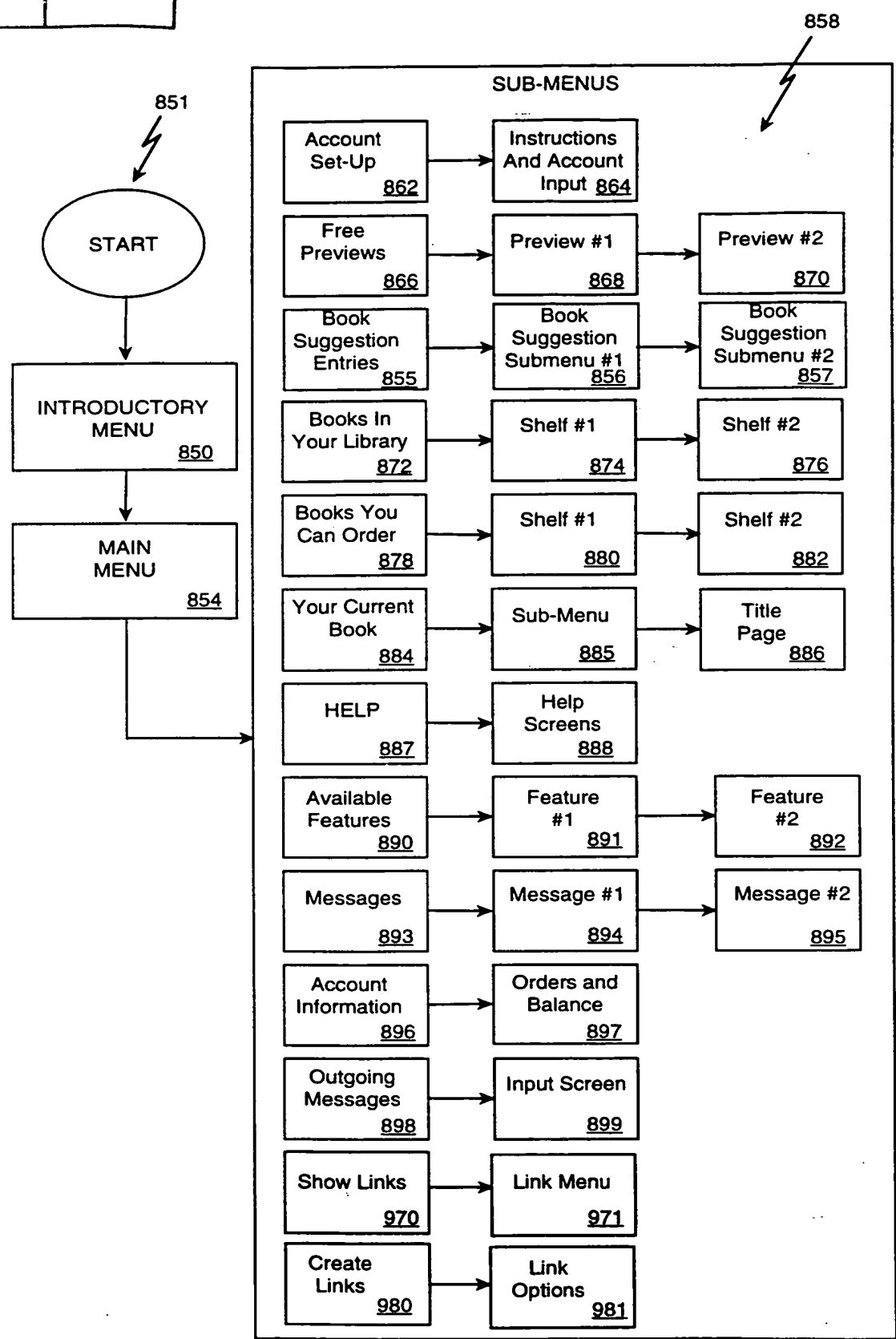
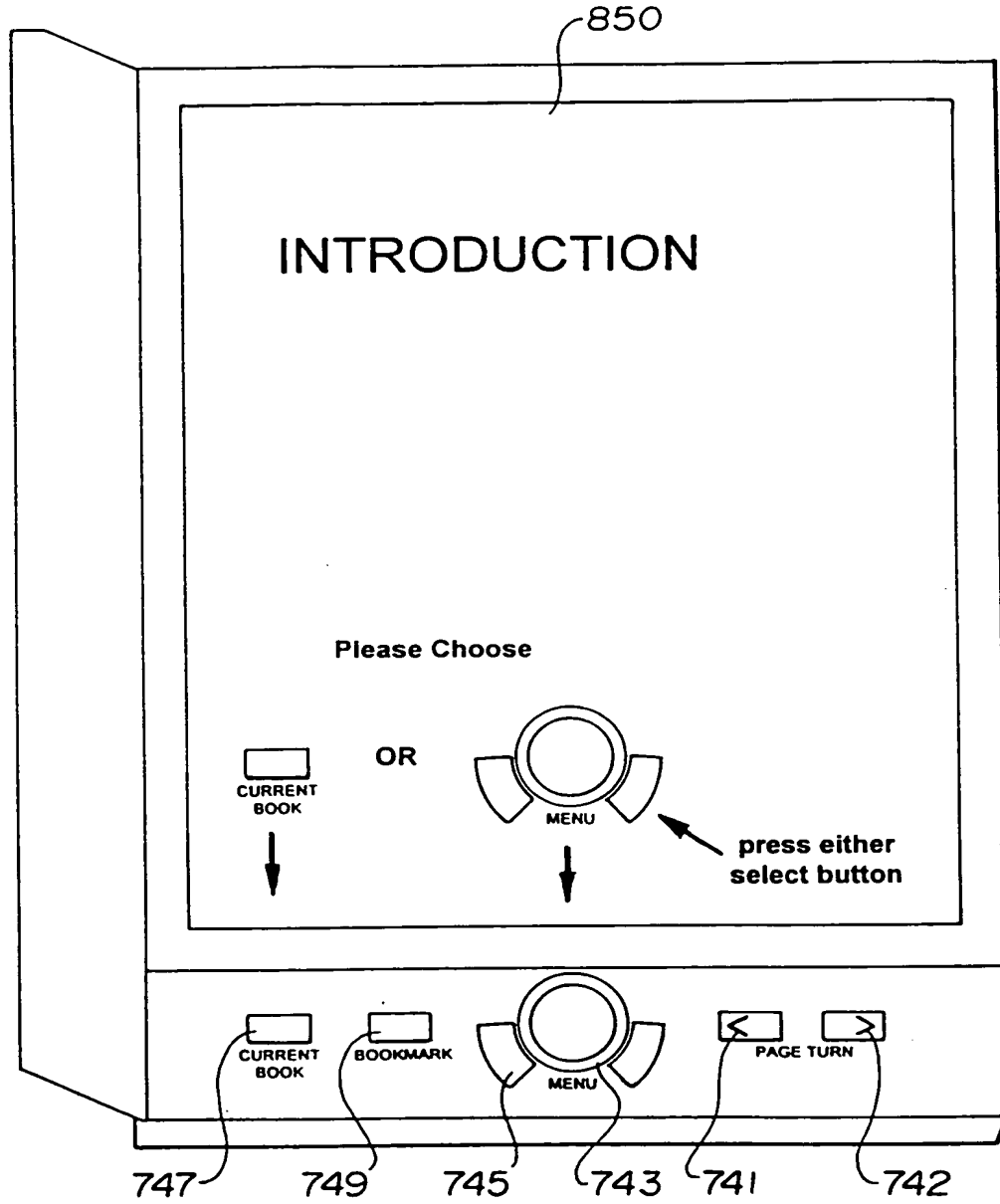

Fig. 13

APPROVED	O.G. FIG.	
BY	CLASS	SUBCLASS
DRAFTSMAN		

Fig. 14a



0935268-061799

APPROVED	O.G. FIG.	
BY	CLASS	SUBCLASS
DRAFTSMAN		

Fig. 14b

854

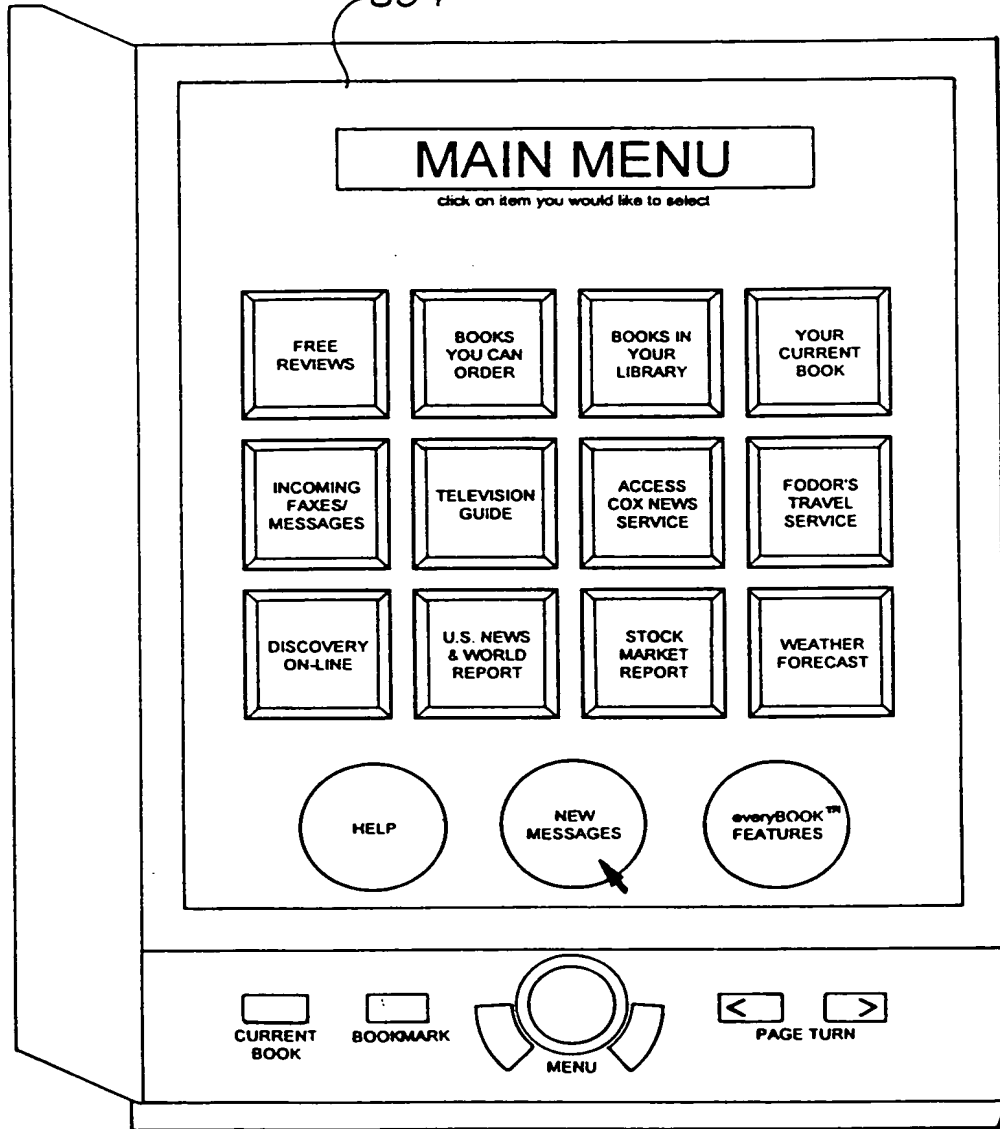

654790" B925E60

APPROVED	O.G. FIG.	
BY	CLASS	SUBCLASS
DRAFTSMAN		

Fig. 14c

872

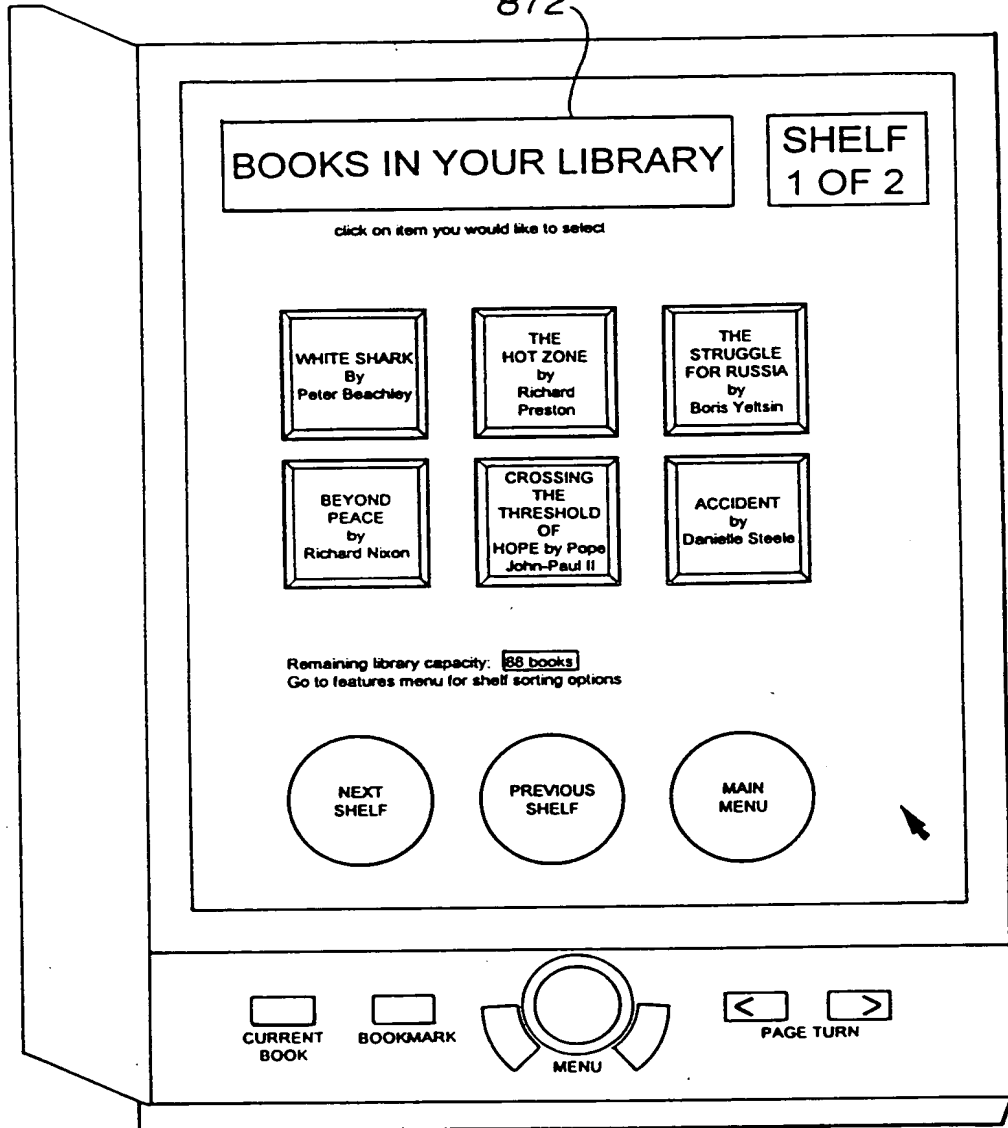

662750-8925EESD

APPROVED	O.G. FIG.	
BY	CLASS	SUBCLASS
DRAFTSMAN		

Fig. 14d

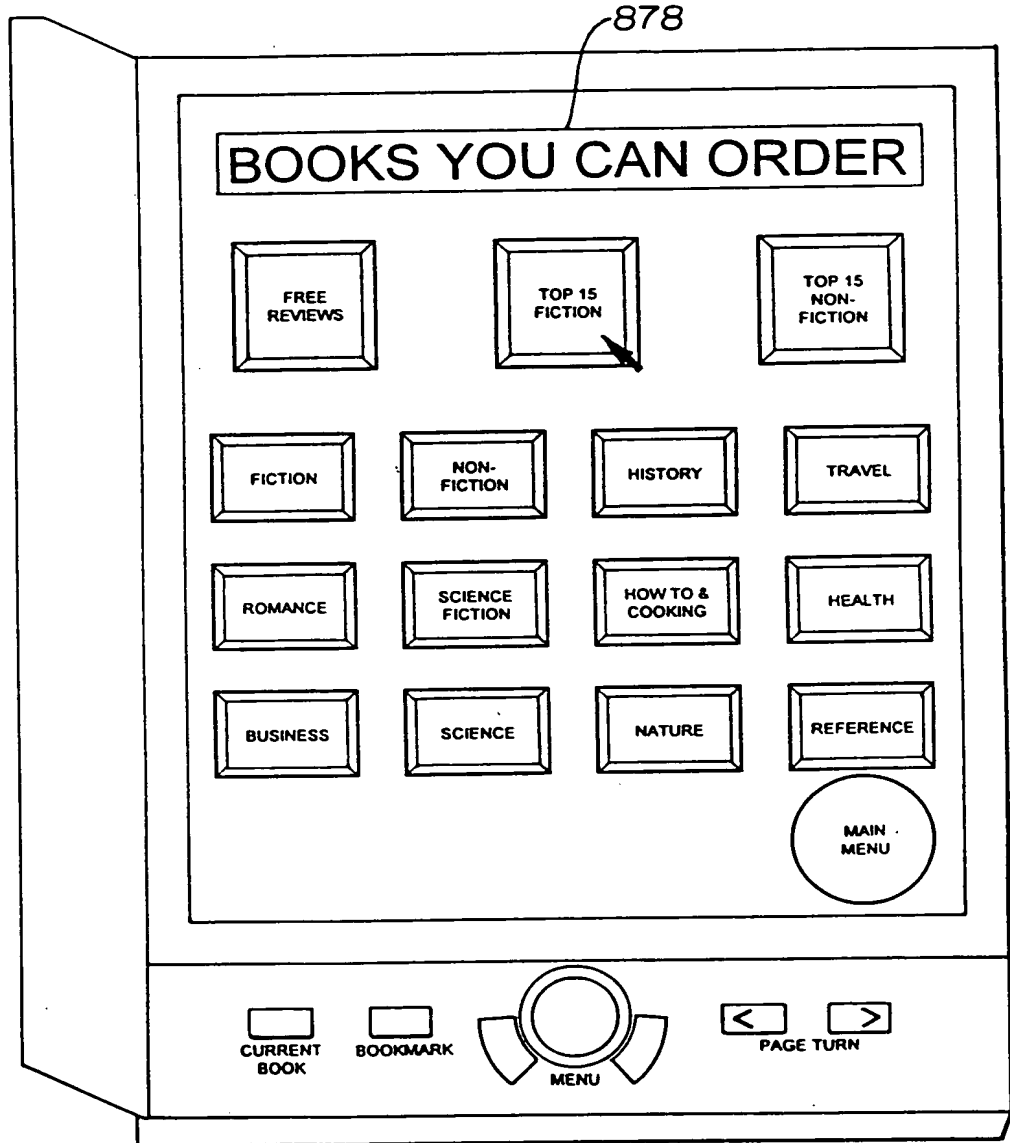

62790-892560

APPROVED	O.G. FIG.	
BY	CLASS	SUBCLASS
DRAFTSMAN		

Fig. 14e

880

662130" 33252660

BOOKS YOU CAN ORDER

TOP 15 FICTION

1. Select title
2. Select order method
3. Select ORDER button

AVAILABLE TITLES

Title	Author	Retail Price
1. North of Hali	T. Fancy	\$24.95
2. Accident	D. Steel	\$23.95
3. Disclosure	M. Crichton	\$24.00
4. Bridges of Madison County	P. Waller	\$16.95
5. Slow Waltz in Cedar Bend	P. Waller	\$16.95
6. Like Water for Chocolate	L. Esquirel	\$17.95
7. Bad Love	J. Ketterman	\$22.95
8. Fatal Cure	R. Cook	\$22.95
9. Family Blessings	L. Spencer	\$22.95
10. Cat Who Came to Breakfast	L. Braun	\$19.95
11. Honor Bound	W.E.B. Griffin	\$22.95
12. The Client	J. Grisham	\$15.95
13. Winter Prey	J. Sandford	\$15.95
14. Schindler's List	T. Kenesaly	\$15.95
15. Prime Witness	S. Martini	\$15.95

everyBOOK™ ORDER METHOD

Cable	Phone	Cellular
\$2.95	\$4.95	\$8.95
\$2.95	\$4.95	\$8.95
\$2.95	\$4.95	\$8.95
\$2.95	\$4.95	\$8.95
\$2.95	\$4.95	\$8.95
\$2.95	\$4.95	\$8.95
\$2.95	\$4.95	\$8.95
\$2.95	\$4.95	\$8.95
\$2.95	\$4.95	\$8.95
\$2.95	\$4.95	\$8.95
\$2.95	\$4.95	\$8.95
\$2.95	\$4.95	\$8.95
\$2.95	\$4.95	\$8.95
\$2.95	\$4.95	\$8.95
\$2.95	\$4.95	\$8.95
\$2.95	\$4.95	\$8.95
\$2.95	\$4.95	\$8.95
\$2.95	\$4.95	\$8.95
\$2.95	\$4.95	\$8.95

ORDER

CANCEL ABOVE

PREVIOUS MENU

MAIN MENU

CURRENT BOOK

BOOKMARK

MENU

<
>
PAGE TURN

APPROVED	O.G. FIG.	
BY	CLASS	SUBCLASS
DRAFTSMAN		

Fig. 14f

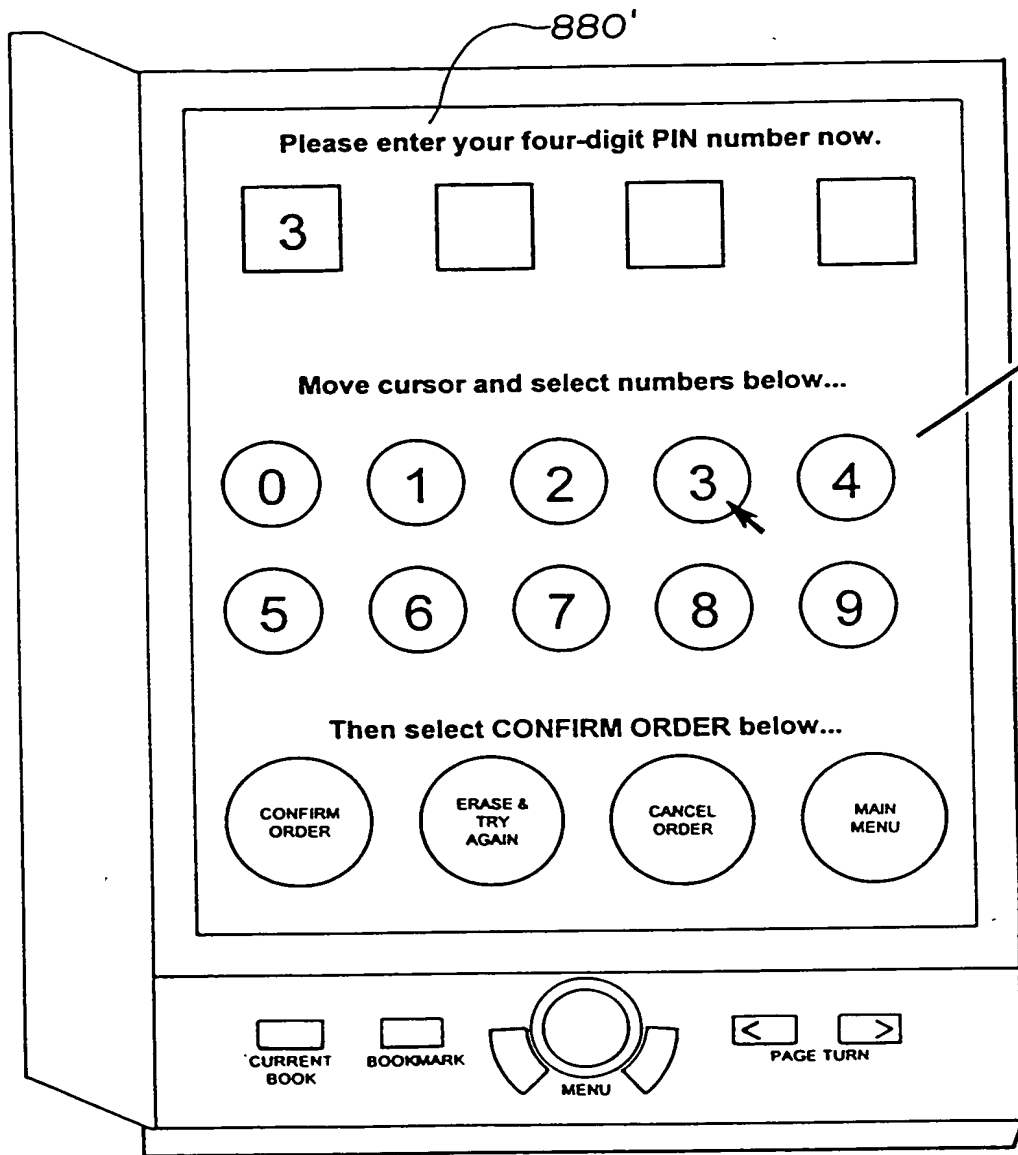

652790-8925E60

APPROVED	O.G. FIG.	
BY	CLASS	SUBCLASS
DRAFTSMAN		

Fig. 14g

862

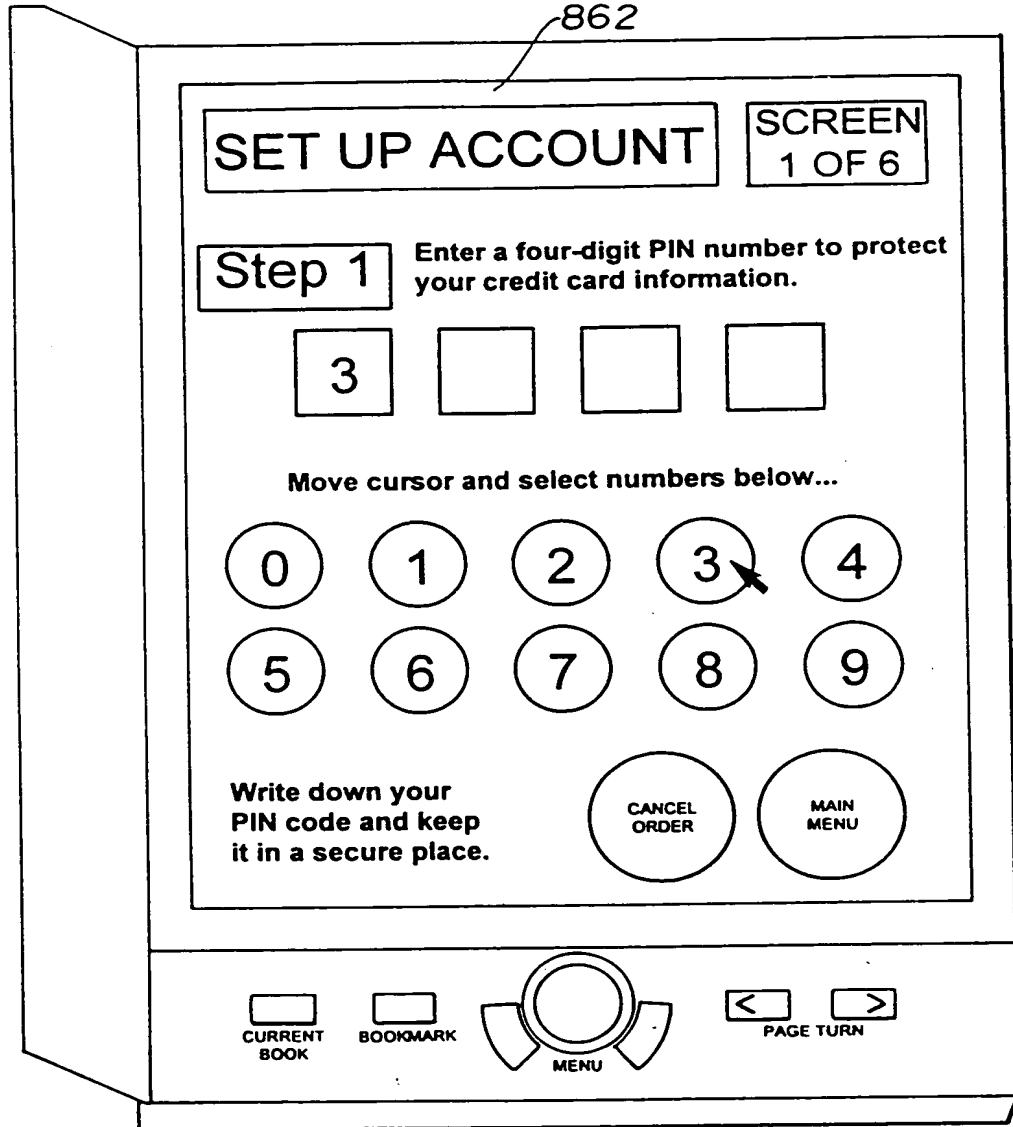

654750" 89256660

APPROVED	O.G. FIG.	
BY	CLASS	SUBCLASS
DRAFTSMAN		

Fig. 14h

864

SET UP ACCOUNT

SCREEN
2 OF 6

Step 2

Select a credit card you wish to use for your everyBOOK™ purchase.

VISA

American Express

Discover

Step 3

Enter your credit card number and expiration date using keypad below.

exp. MM YY

MM

YY

Step 4

Enter your home phone number using the keypad below.

area code

area code

area code

662790-8925E60

APPROVED	O.G. FIG.	
BY	CLASS	SUBCLASS
DRAFTSMAN		

Fig. 14i

866

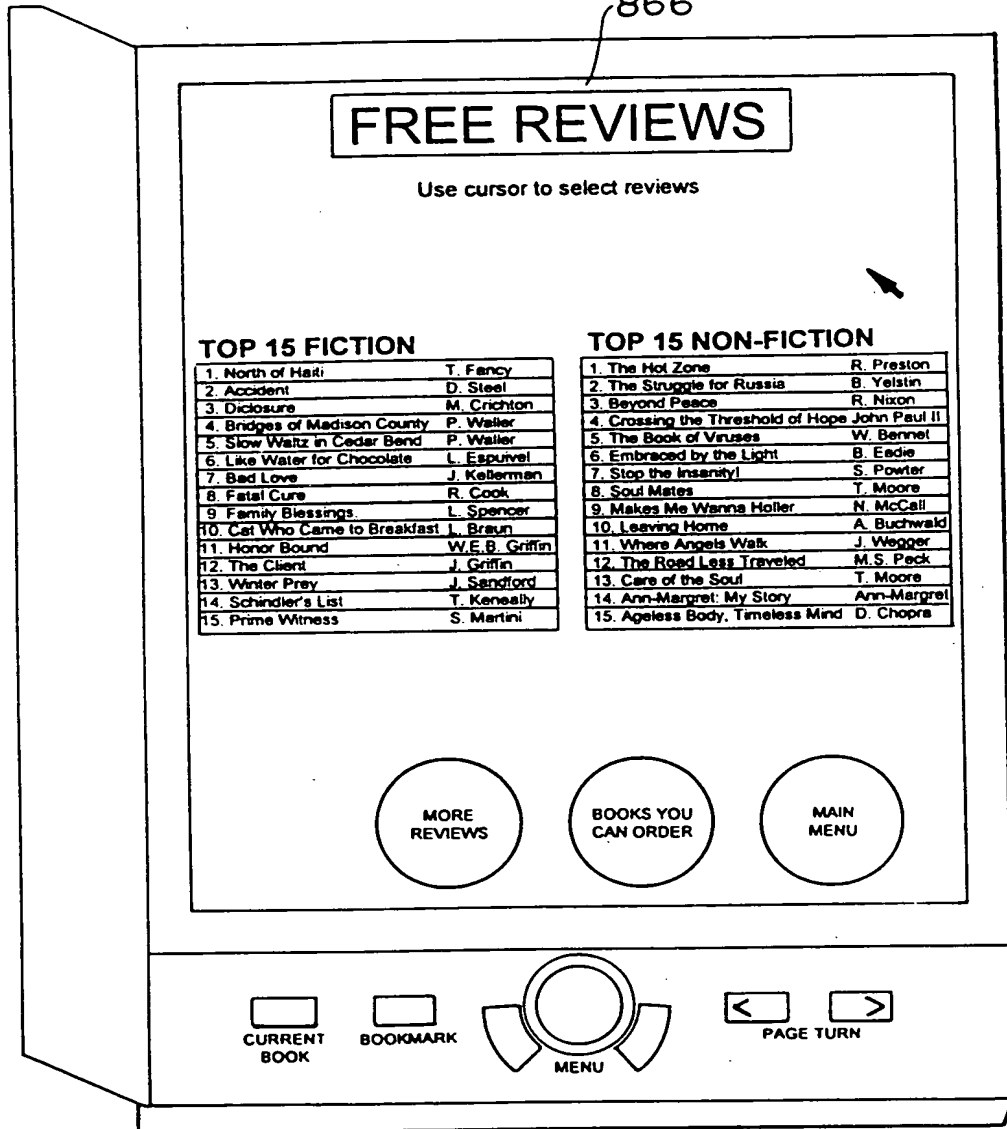

FREE REVIEWS

Use cursor to select reviews

TOP 15 FICTION

1. North of Haidi	T. Fancy
2. Accident	D. Steel
3. Disclosure	M. Crichton
4. Bridges of Madison County	P. Walker
5. Slow Water in Cedar Bend	P. Walker
6. Like Water for Chocolate	L. Esquivel
7. Bad Love	J. Kellerman
8. Fatal Cure	R. Cook
9. Family Blessings	L. Spencer
10. Cat Who Came to Breakfast	L. Braun
11. Honor Bound	W.E.B. Griffin
12. The Client	J. Griffin
13. Winter Prey	J. Sandford
14. Schindler's List	T. Keneally
15. Prime Witness	S. Martini

TOP 15 NON-FICTION

1. The Hot Zone	R. Preston
2. The Struggle for Russia	B. Yelstin
3. Beyond Peace	R. Nixon
4. Crossing the Threshold of Hope	John Paul II
5. The Book of Viruses	W. Bernal
6. Embraced by the Light	B. Eadie
7. Stop the Insanity!	S. Power
8. Soul Mates	T. Moore
9. Makes Me Wanna Holler	N. McCall
10. Leaving Home	A. Buchwald
11. Where Angels Walk	J. Wegger
12. The Road Less Traveled	M.S. Peck
13. Care of the Soul	T. Moore
14. Ann-Margret: My Story	Ann-Margret
15. Ageless Body, Timeless Mind	D. Chopra

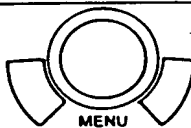
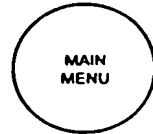

PAGE TURN

664790" 0925E50

APPROVED	O.G. FIG.	
BY	CLASS	SUBCLASS
DRAFTSMAN		

Fig. 14j

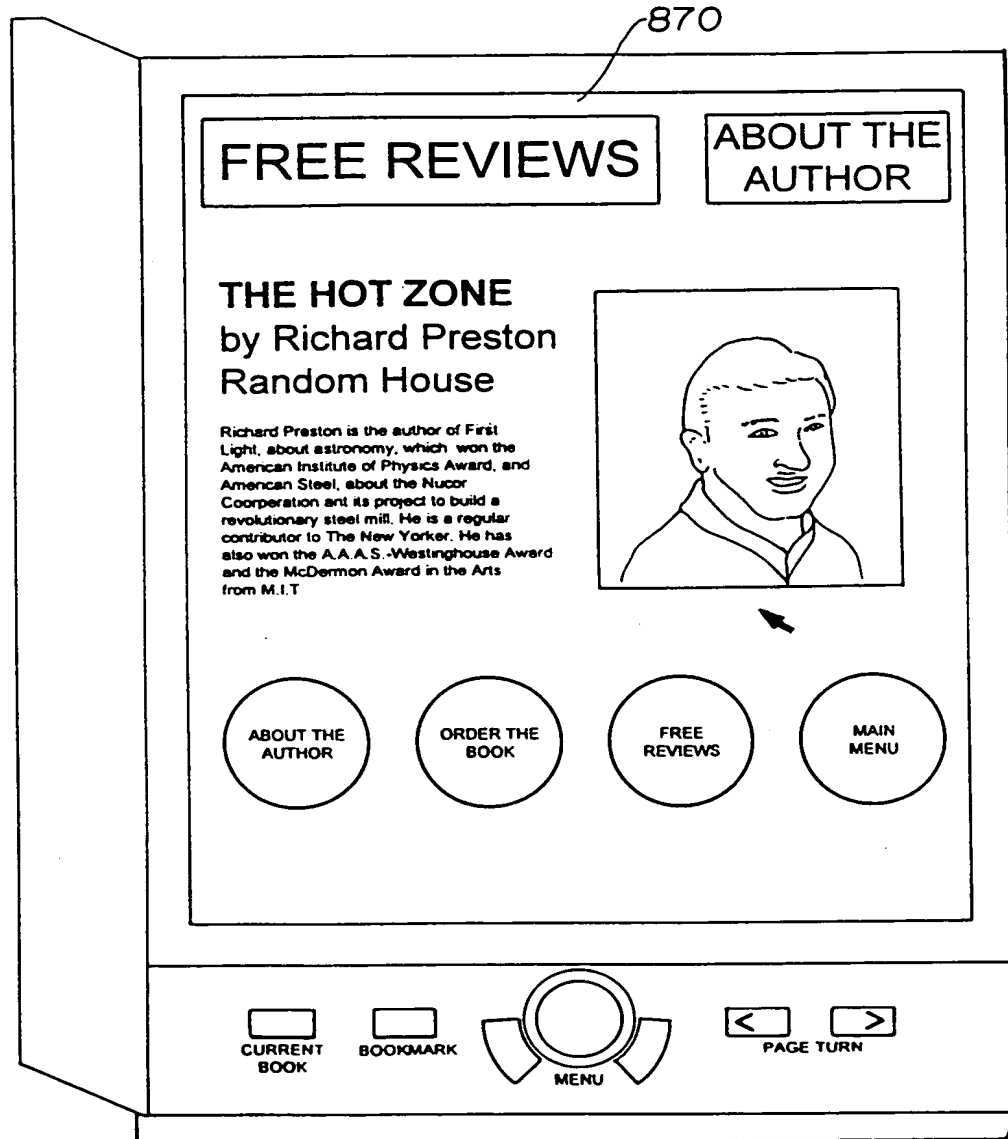

PAT. 5,082,550

APPROVED	O.G. FIG.	
BY	CLASS	SUBCLASS
DRAFTSMAN		

Fig. 15

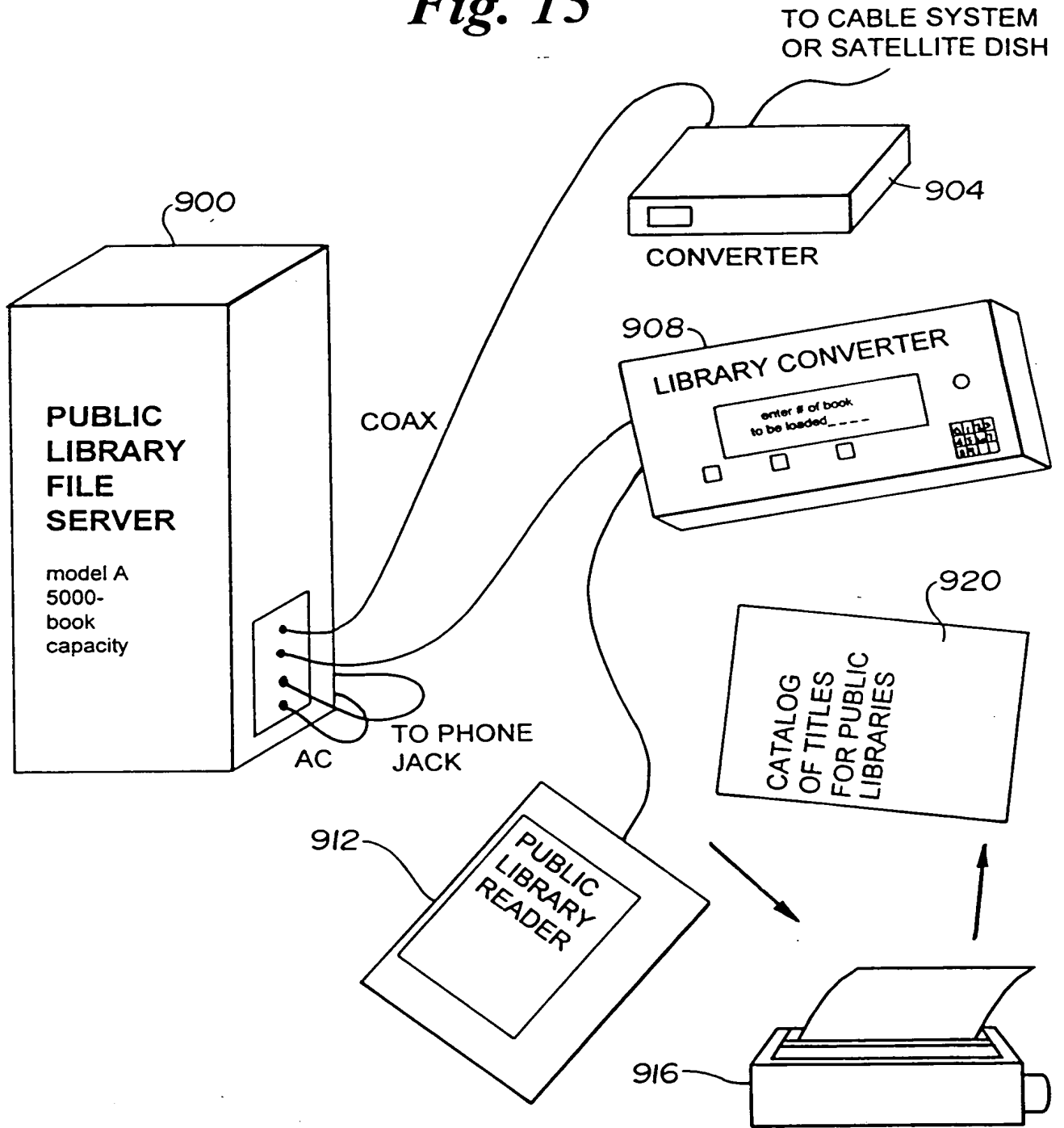

662130" 8925560

APPROVED	O.G. FIG.	
BY	CLASS	SUBCLASS
DRAFTSMAN		

62730" 625566

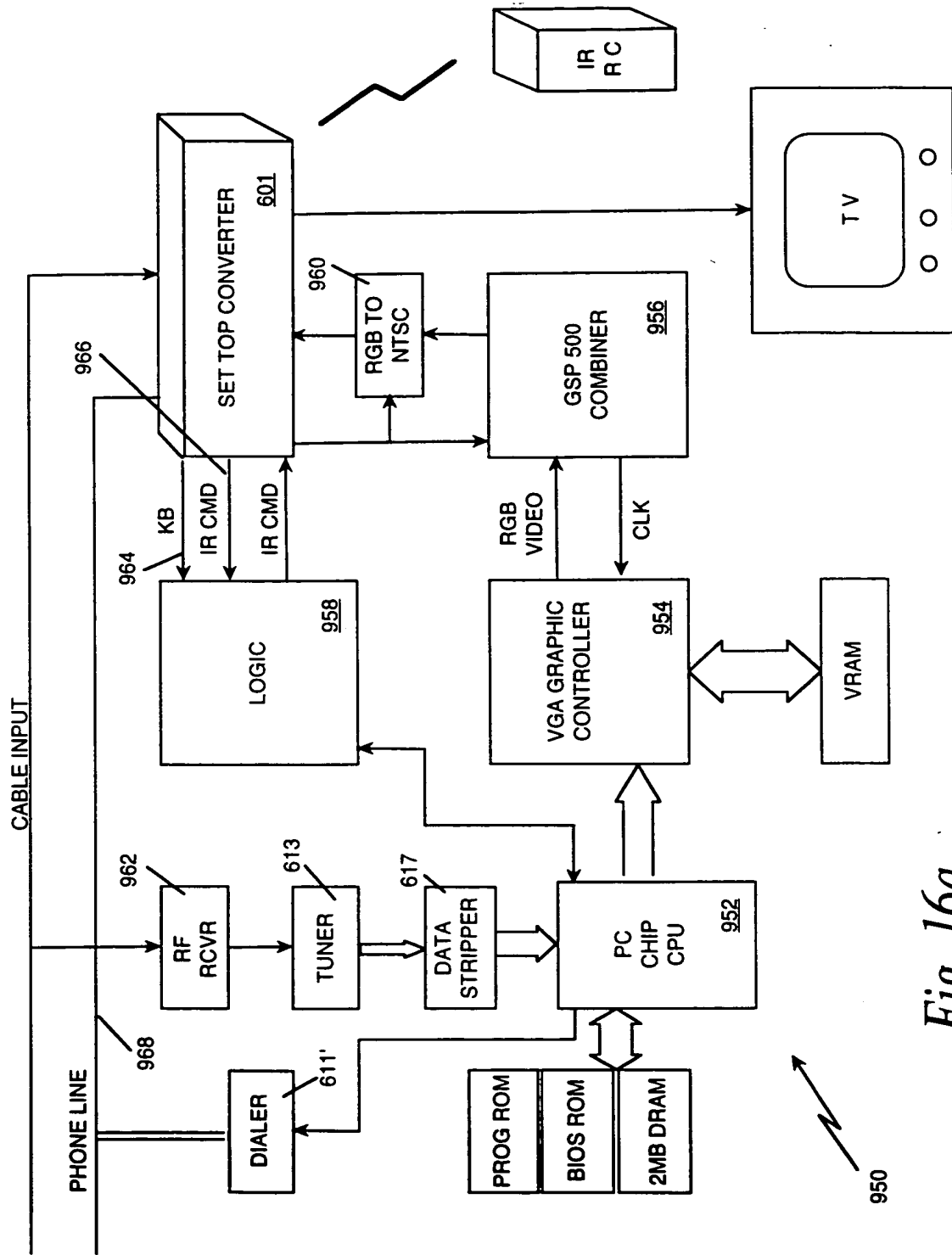

Fig. 16a

APPROVED	O.G. FIG.	
BY	CLASS	SUBCLASS
DRAFTSMAN		

662F90" B925E60

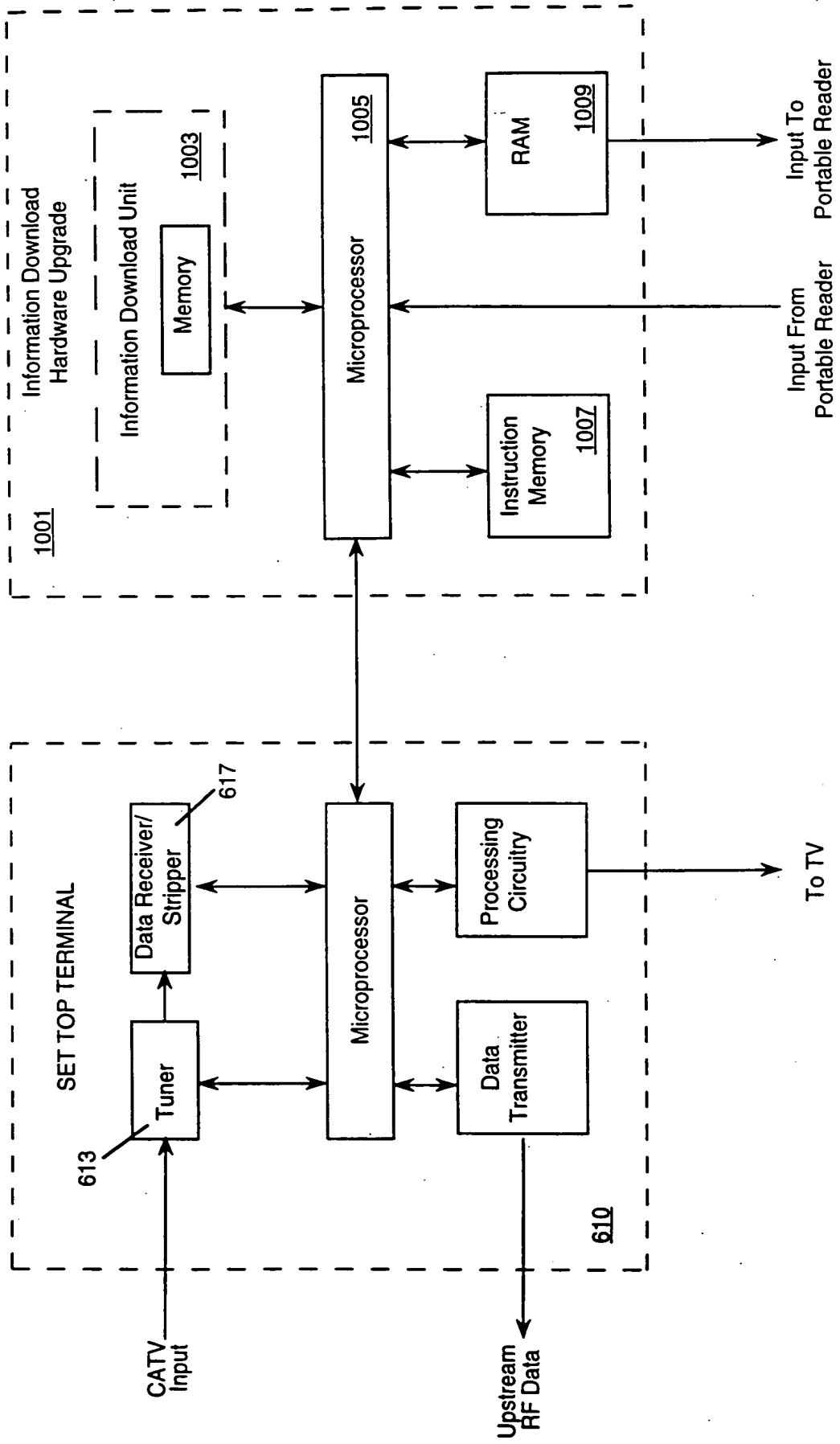

Fig. 16b

APPROVED	O.G. FIG.	
BY	CLASS	SUBCLASS
DRAFTSMAN		

PAT 3,925,660

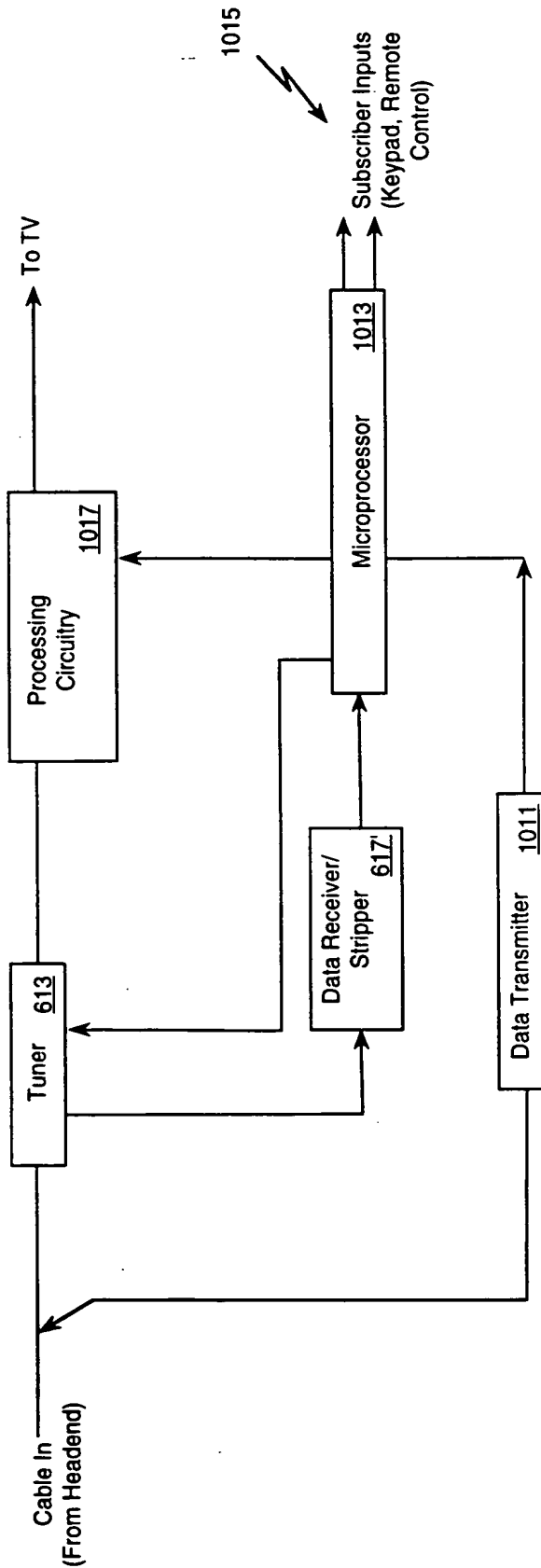
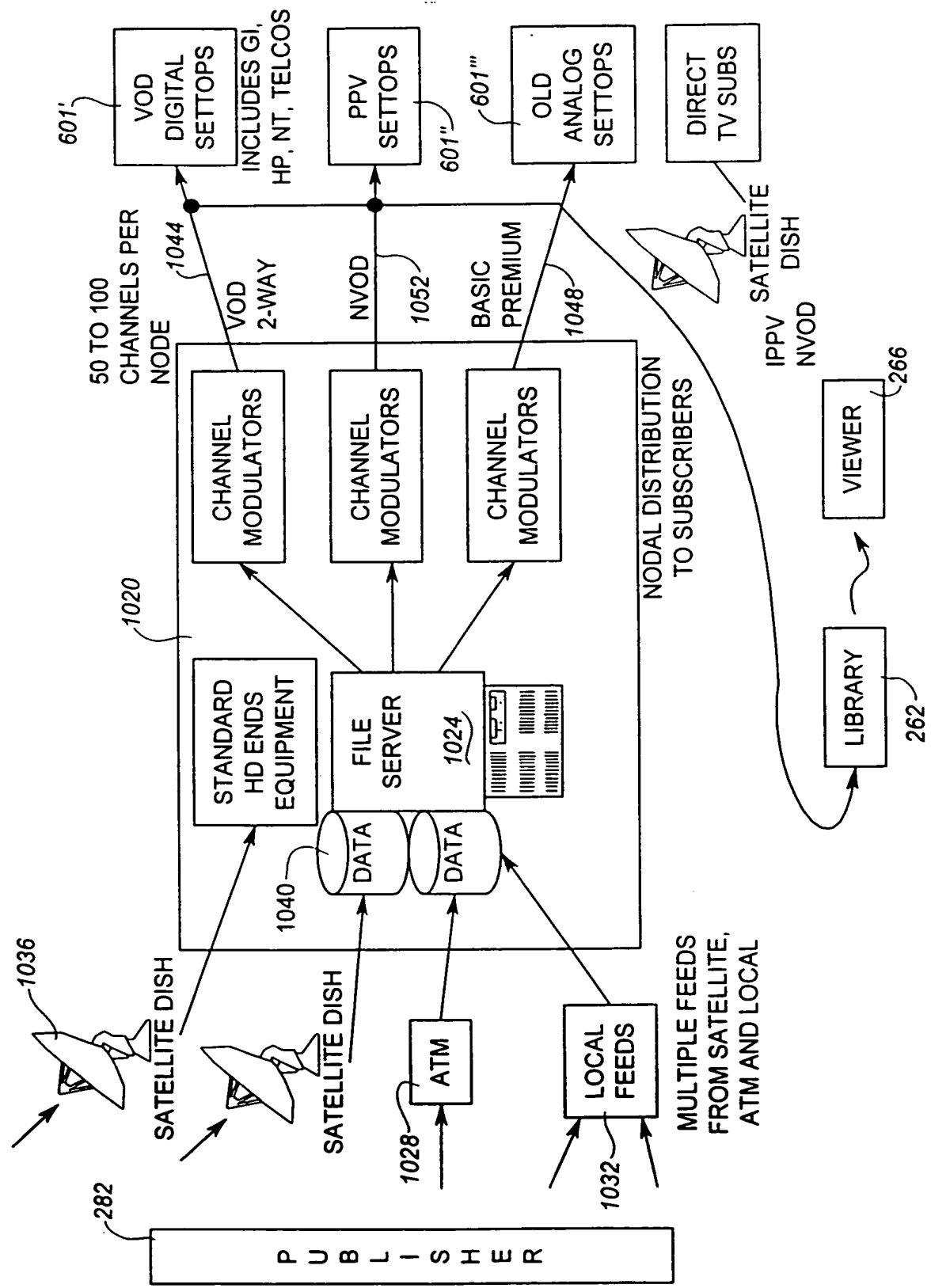

Fig. 17

652790-8925660

Fig. 18a



66730-33550

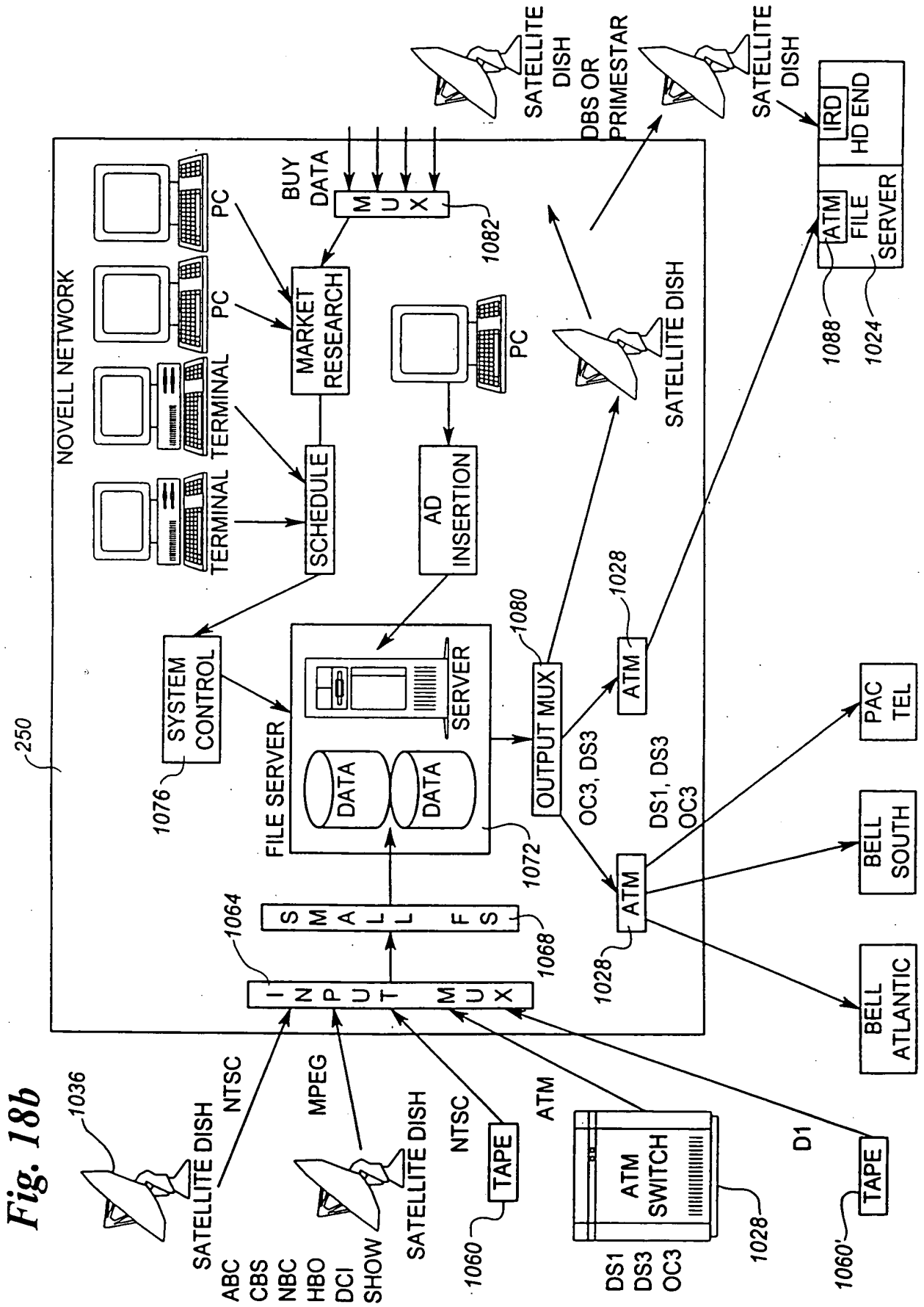

62790-825650

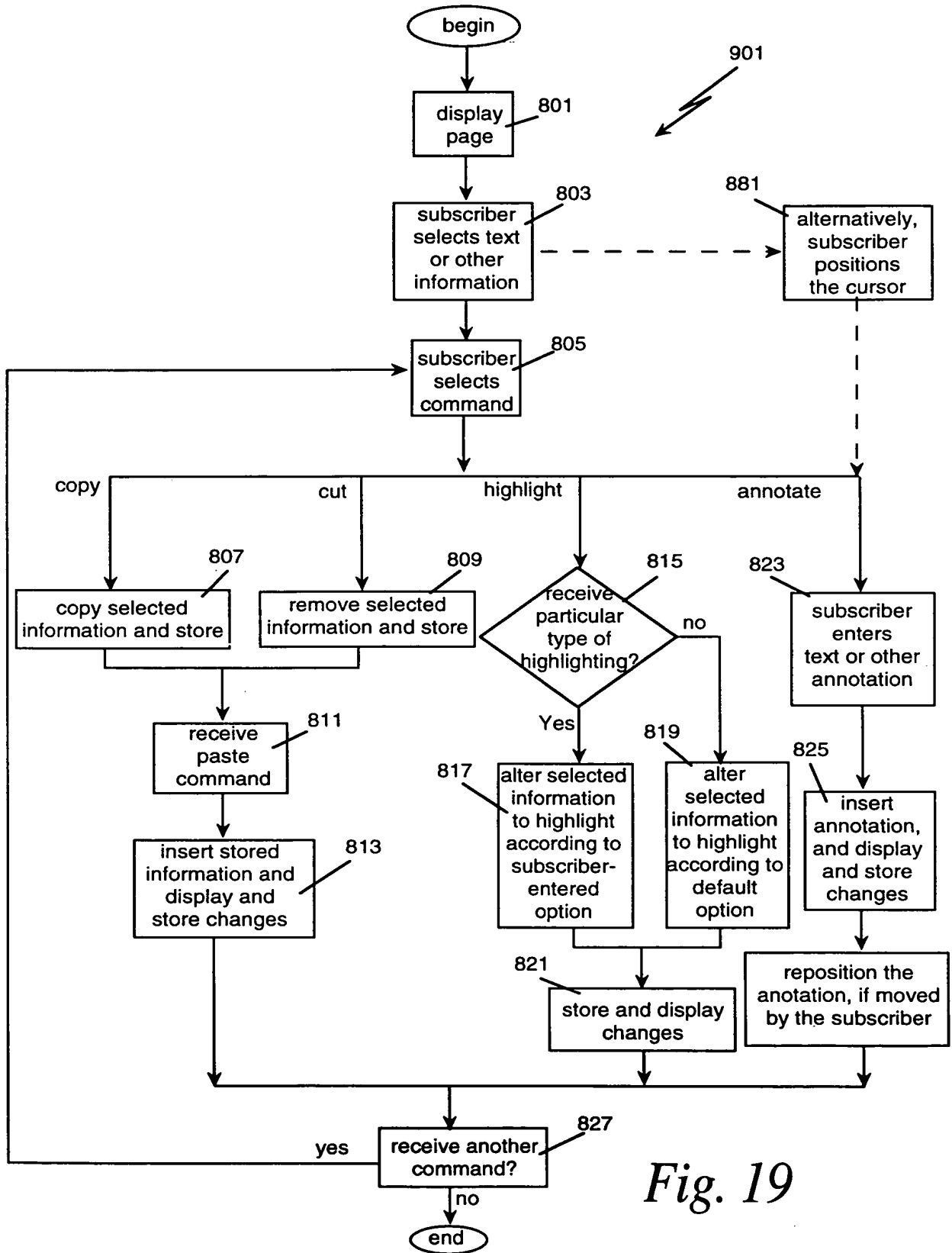

Fig. 19

APPROVED	O.G. FIG.	
BY	CLASS	SUBCLASS
DRAFTSMAN		

Fig. 20

1200

1201

ical demands: the resignation of Gorbachev. To be sure, as part of Ukraine, Donbas was now on Leonid Kravchuk's conscience. Vorkuta and Kuzbas were coal-mining areas I had visited a number of times and to which I would certainly return. Their demands were harshly formulated at times, and they expected a great deal from me, but they supported me during the tough reforms.

We have a saying in Russia that when you chop wood, the chips fly. Although Khasbulatov tried his best to portray the miners as economic chips flying from the Gaidar team's woodcutting, their demands did not fit the picture. These miners were not against reform.

Nevertheless, they did try to defend their economic interests, insisting that such hard work should be rewarded with part of the overall profits from the industry. Unfortunately, we did not have precise mechanisms to turn such enterprises as coal mines into joint stock companies. There were long, hard negotiations under way constantly.

I must say that in the spring and summer of 1992, when the word *stoppage* resounded throughout the country (the work stoppage on trains with coal, the stoppage on factory floors, the stoppage of transportation), my old Yuri Skokov very courageously conducted the negotiations with the miners.

I met Yuri Skokov when I worked at the Moscow City Executive Committee. He was director of Quantum, a large defense plant, and he had run for elections to the Soviet parliament against Vitaly Korotich, a prominent writer and journalist who at the time was editor in chief of *Ogonyok (Little Flame)*, a pioneer of glasnost. Due to various backroom deals and party scheming (described in *Against the Grain*), Skokov won the election and proved himself to be a disciplined party protege.

Skokov is an intelligent man—that is the first thing that must be said about him. And very hard and taciturn. Many people were asking what his role was in my inner circle. It was a legitimate question. Skokov was actually the "shadow" prime minister whom I had always had in mind. Both Silayev, under whom Skokov chaired the Supreme Economic Counsel, and Gaidar, on whose watch Skokov became chairman of the Security Council, sensed a latent threat.

1214

menu | p-t-p | split-inset-swap | normal | multi-page |

| multi-screen | highlight | annotate | cut | copy | paste

1231

1215

09335568-061799

062790-8925560

Fig. 21

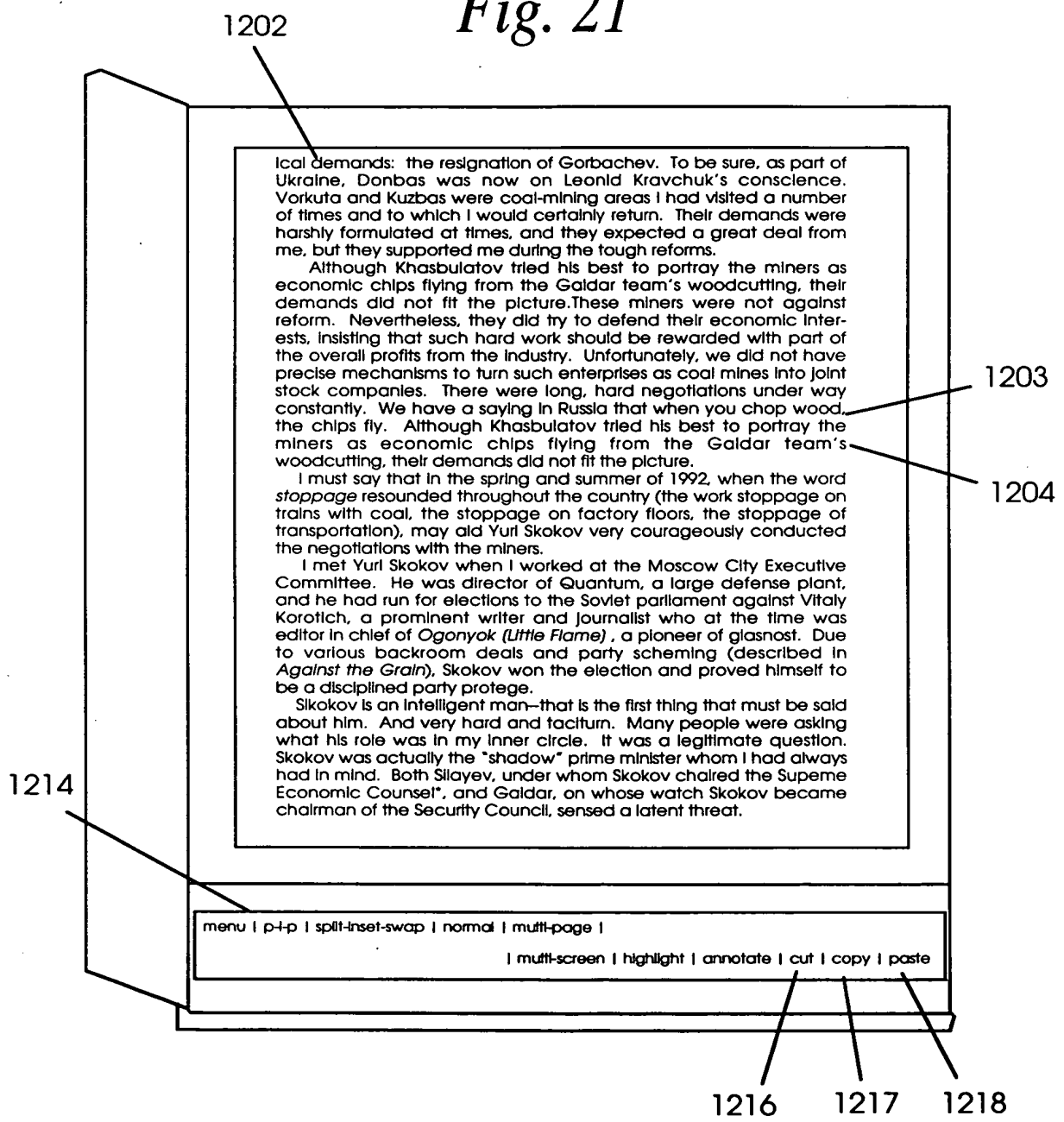

APPROVED	O.G. FIG.	
BY	CLASS	SUBCLASS
DRAFTSMAN		

Fig. 22

1202

ical demands: the resignation of Gorbachev. To be sure, as part of Ukraine, Donbas was now on Leonid Kravchuk's conscience. Vorkuta and Kuzbas were coal-mining areas I had visited a number of times and to which I would certainly return. Their demands were harshly formulated at times, and they expected a great deal from me, but they supported me during the tough reforms.

We have a saying in Russia that when you chop wood, the chips fly.

Although Khasbulatov tried his best to portray the miners as economic chips flying from the Gaidar team's woodcutting, their demands did not fit the picture. These miners were not against reform. Nevertheless, they did try to defend their economic interests, insisting that such hard work should be rewarded with part of the overall profits from the industry. Unfortunately, we did not have precise mechanisms to turn such enterprises as coal mines into joint stock companies. There were long, hard negotiations under way constantly.

I must say that in the spring and summer of 1992, when the word *stoppage* resounded throughout the country (the work stoppage on trains with coal, the stoppage on factory floors, the stoppage of transportation), may aid Yuri Skokov very courageously conducted the negotiations with the miners.

I met Yuri Skokov when I worked at the Moscow City Executive Committee. He was director of Quantum, a large defense plant, and he had run for elections to the Soviet parliament against Vitaly Korotich, a prominent writer and journalist who at the time was editor in chief of *Ogonyok (Little Flame)*, a pioneer of glasnost. Due to various backroom deals and party scheming (described in *Against the Grain*), Skokov won the election and proved himself to be a disciplined party protege.

Skokov is an intelligent man—that is the first thing that must be said about him. And very hard and taciturn. Many people were asking what his role was in my inner circle. It was a legitimate question. Skokov was actually the "shadow" prime minister whom I had always had in mind. Both Silayev, under whom Skokov chaired the Supreme Economic Counsel, and Gaidar, on whose watch Skokov became chairman of the Security Council, sensed a latent threat.

annotation

1206

1214

menu | p-t-p | split-inset-swap | normal | multi-page |

| multi-screen | highlight | annotate | cut | copy | paste

1219

654790" 8925660

APPROVED	O.G. FIG.	
BY	CLASS	SUBCLASS
DRAFTSMAN		

554T90" 825E60

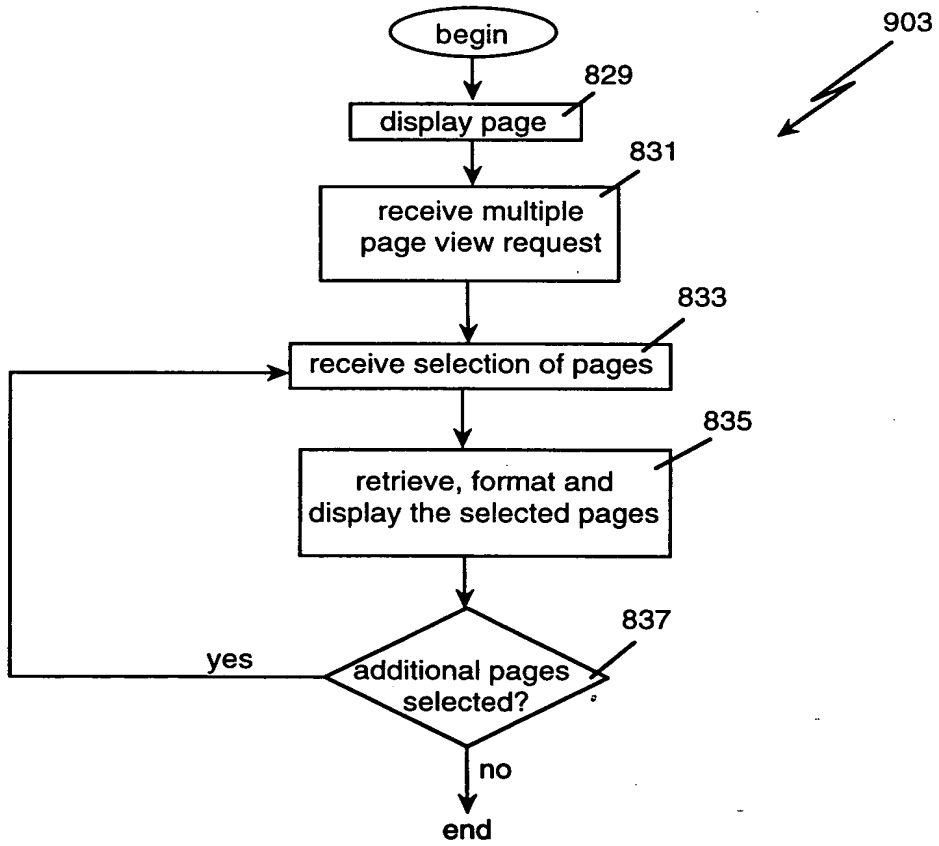
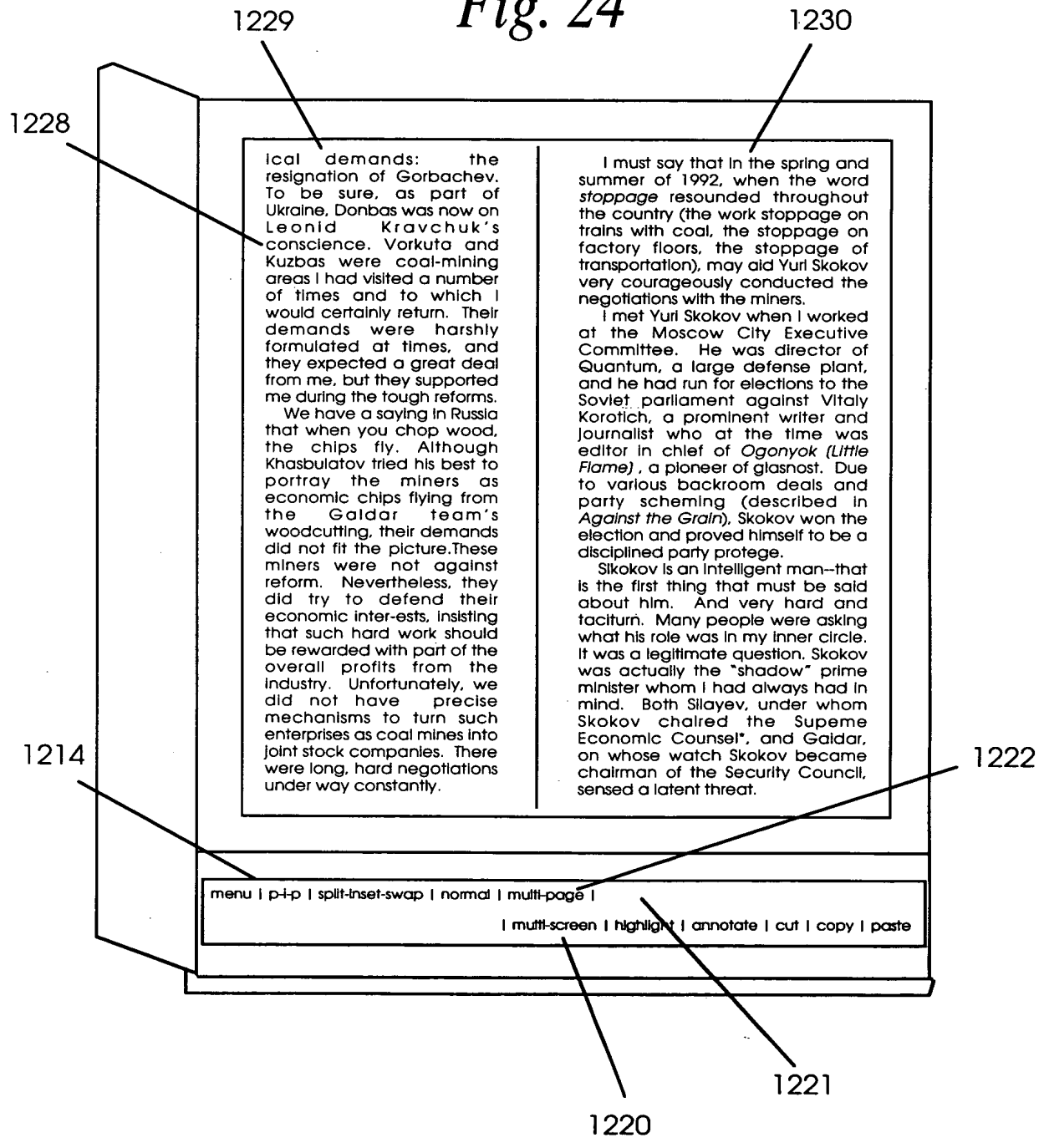
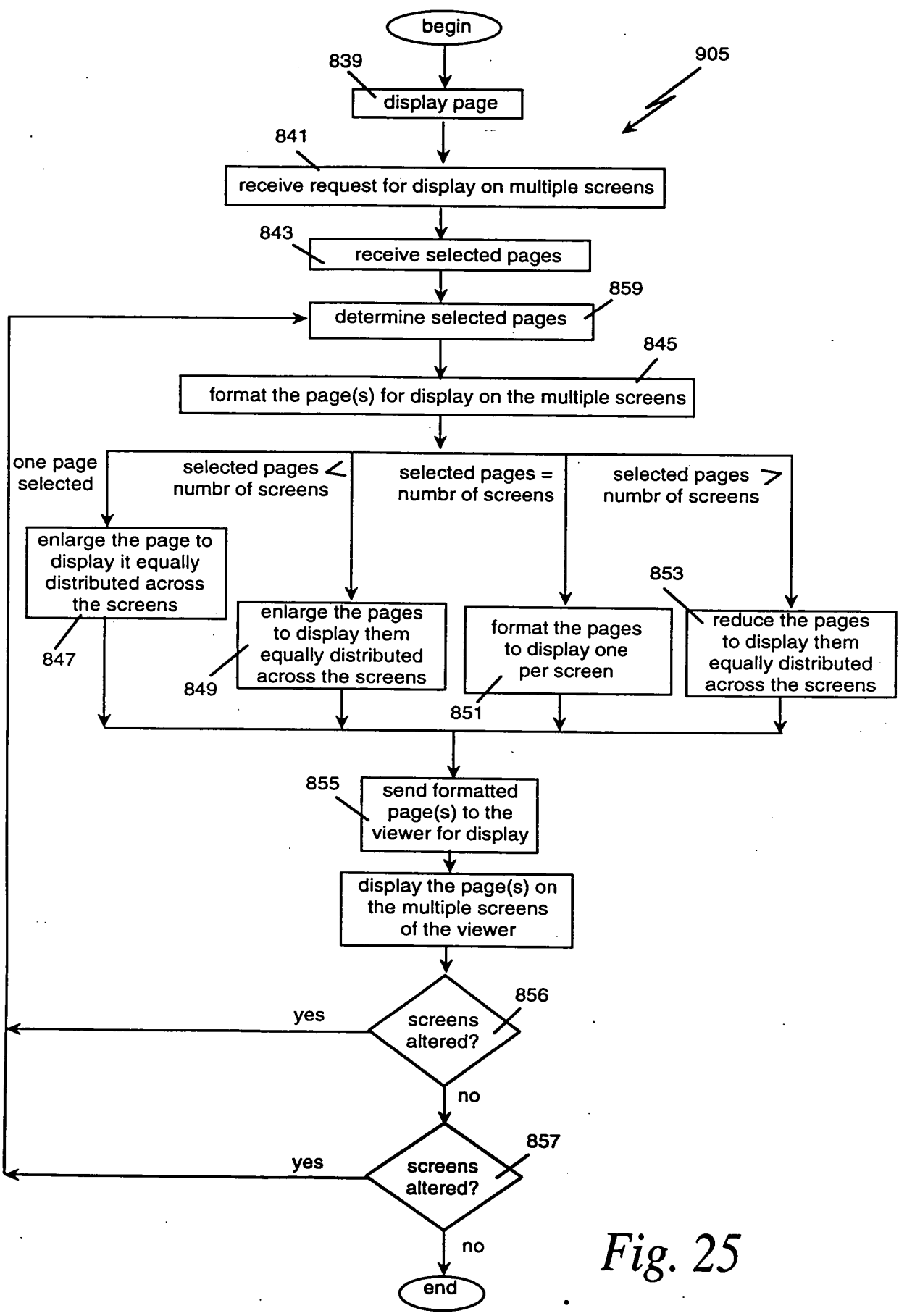

Fig. 23

Fig. 24

664790" 8925260





662790-00255650

Fig. 25

APPROVED	O.G. FIG.	
BY	CLASS	SUBCLASS
DRAFTSMAN		

092558 06790 8925560

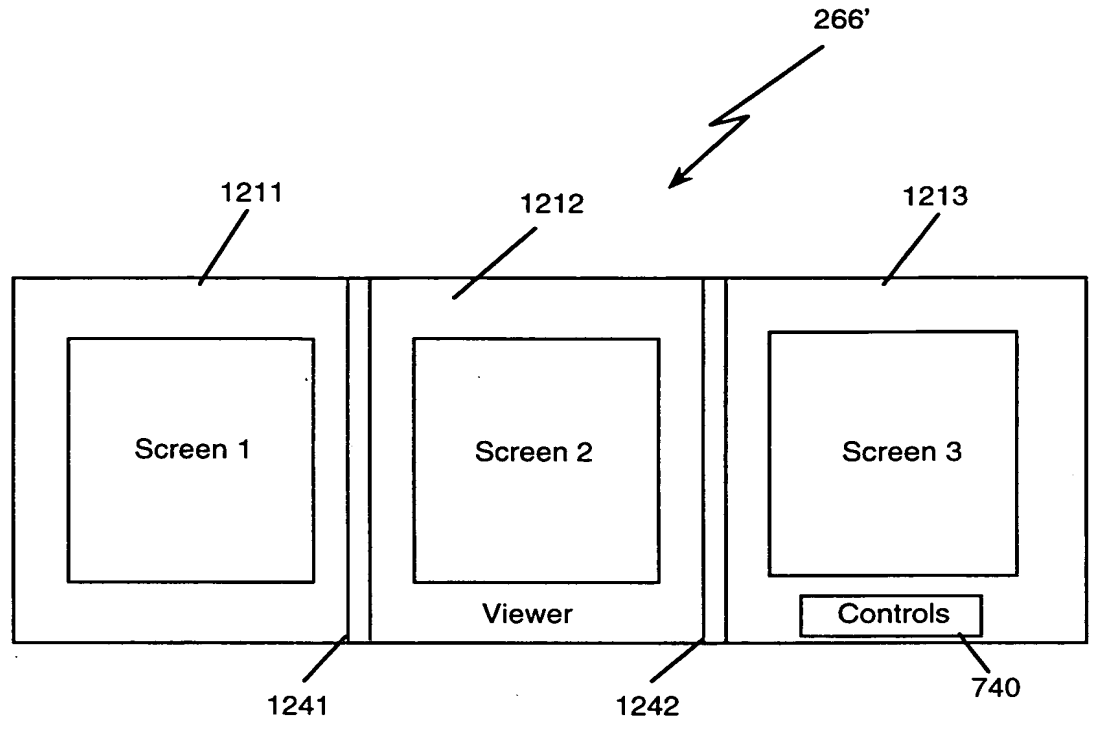

Fig. 26a

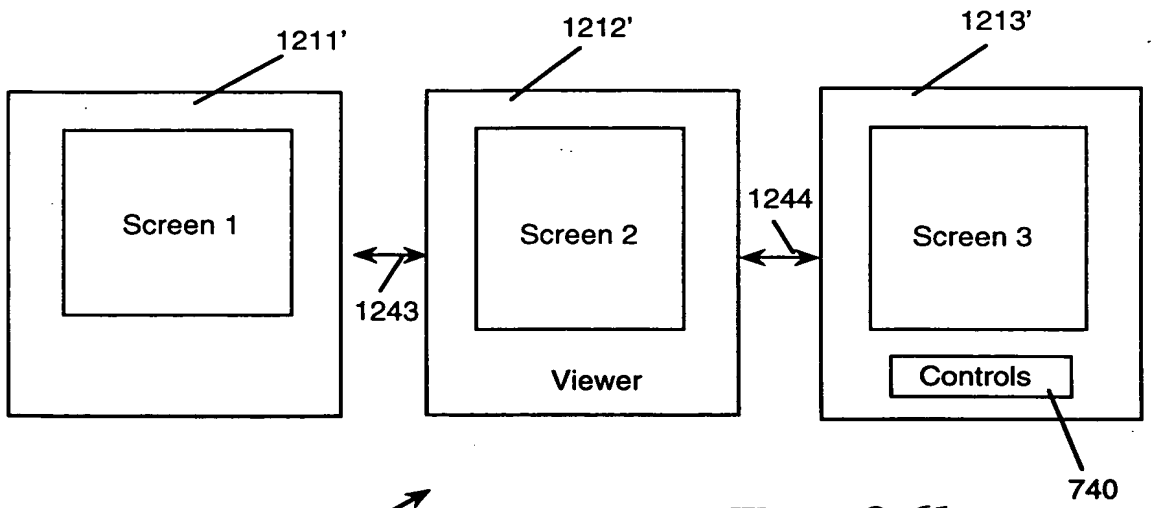

Fig. 26b

APPROVED	O.G. FIG.	
BY	CLASS	SUBCLASS
DRAFTSMAN		

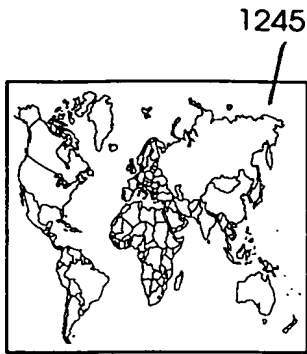

Fig. 26c

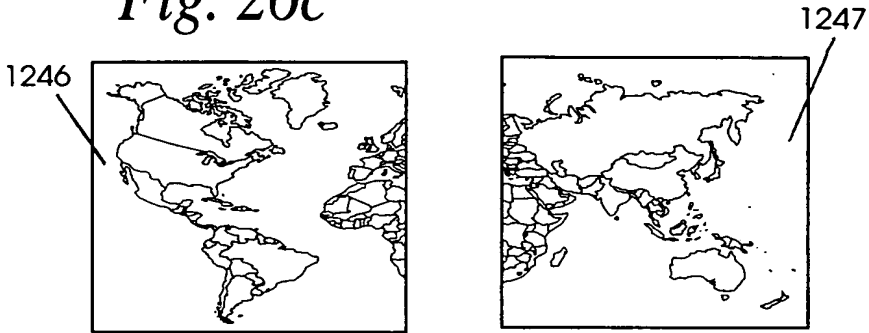

Fig. 26d

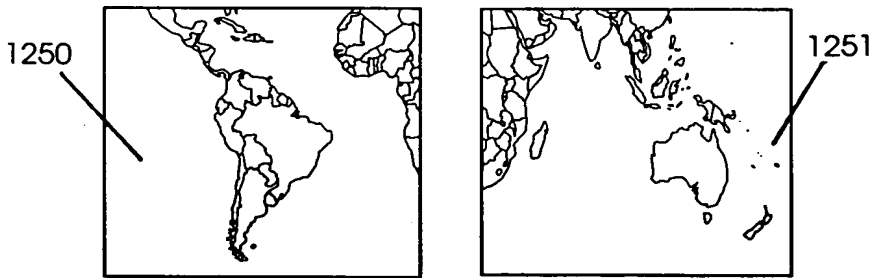
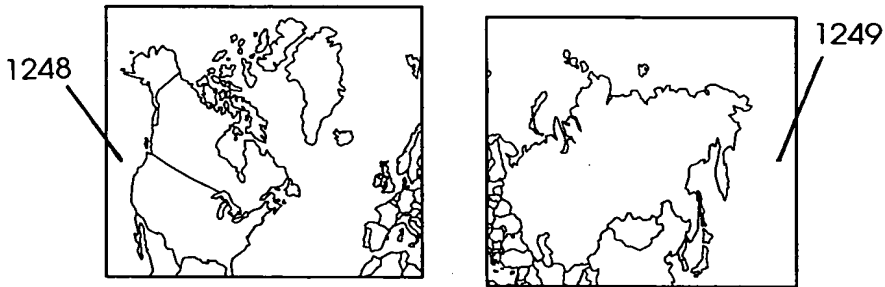
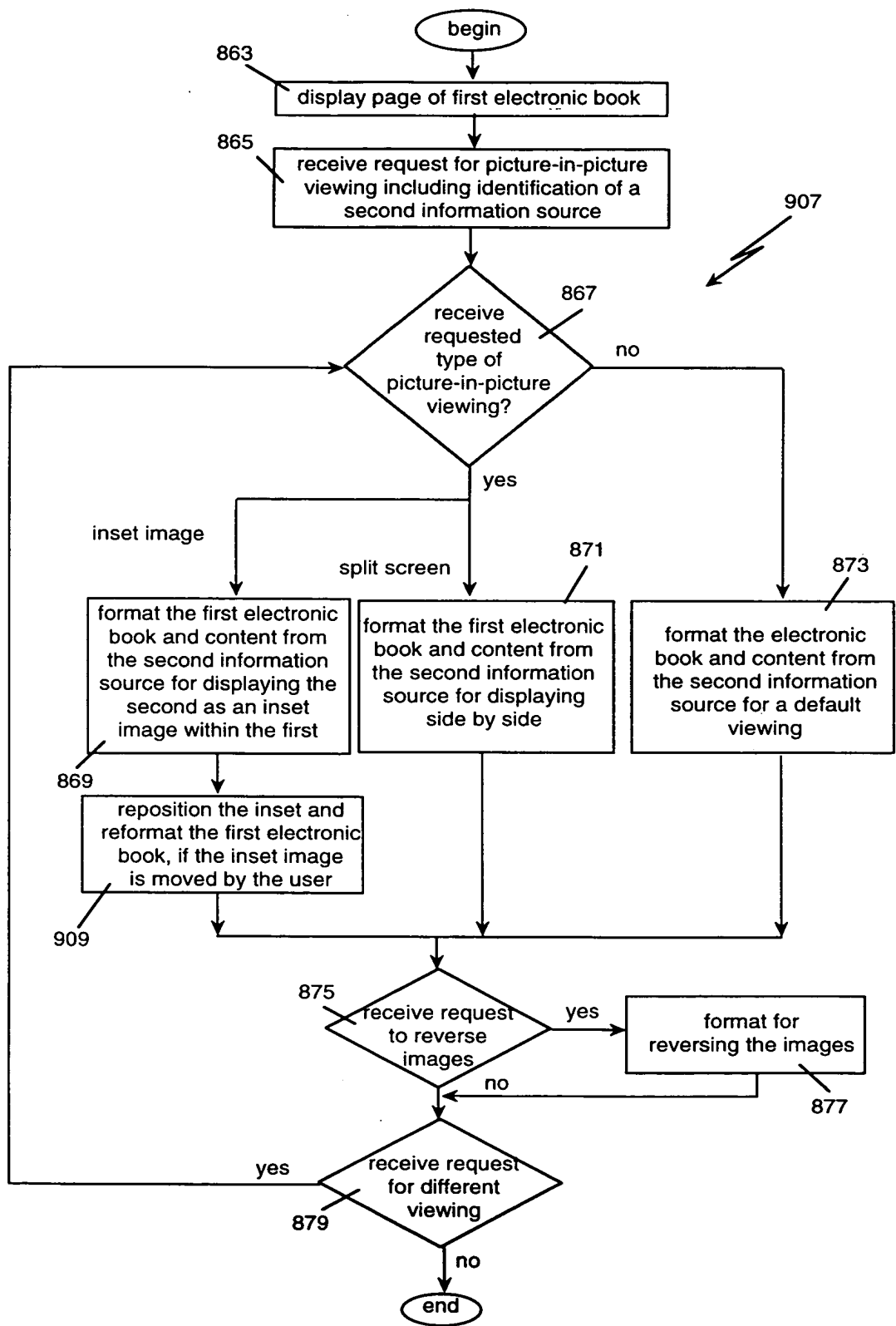

Fig. 26e

093550 89255560



654793

Fig. 27

Fig. 28a

1207

1208

ical demands: the resignation of Gorbachev. To be sure, as part of Ukraine, Donbas was now on Leonid Kravchuk's conscience. Vorkuta and Kuzbas were coal-mining areas I had visited a number of times and to which I would certainly return. Their demands were harshly formulated at times, and they expected a great deal from me, but they supported me during the tough reforms.

We have a saying in Russia that when you chop wood, the chips fly. Although Khasbulatov tried his best to portray the miners as economic chips flying from the Galdar team's woodcutting, their demands did not fit the picture. These miners were not against reform. Nevertheless, they did try to defend their economic inter-ests, insisting that such hard work should be rewarded with part of the overall profits from the industry. Unfortunately, we did not have precise mechanisms to turn such enterprises as coal mines into joint stock companies. There were long, hard negotiations under way constantly.

I must say that in the spring and summer of 1992, when the word *stoppage* resounded throughout the country (the work stoppage on trains with coal, the stoppage on factory floors, the stoppage of transportation), may aid Yuri Skokov very courageously conducted the negotiations with the miners.

I met Yuri Skokov when I worked at the Moscow City Executive Committee. He was director of Quantum, a large defense plant, and he had run for elections to the Soviet parliament against Vitaly Korotich, a prominent writer and journalist who at the time was editor in chief of *Ogonyok (Little Flame)*, a pioneer of glasnost. Due to various backroom deals and party scheming (described in *Against the Grain*), Skokov won the election and proved himself to be a disciplined party protege.

Skokov is an intelligent man—that is the first thing that must be said about him. And very hard and taciturn. Many people were asking what his role was in my inner circle. It was a legitimate question. Skokov was actually the "shadow" prime minister whom I had always had in mind. Both Silayev, under whom Skokov chaired the Supreme Economic Counsel, and Galdar, on whose watch Skokov became chairman of the Security Council, sensed a latent threat.

I must say that in the spring and summer of 1992, when the word *stoppage* resounded throughout the country (the work stoppage on trains with coal, the stoppage on factory floors, the stoppage of transportation), may

1214

menu | p-t-p | split-inset-swap | normal | multi-page |
 | multi-screen | highlight | annotate | cut | copy | paste

1231 1223 1224 1225 1226 1227

00335258 051799

APPROVED	O.G. FIG.	
BY	CLASS	SUBCLASS
DRAFTSMAN		

Fig. 28b

693555-00179

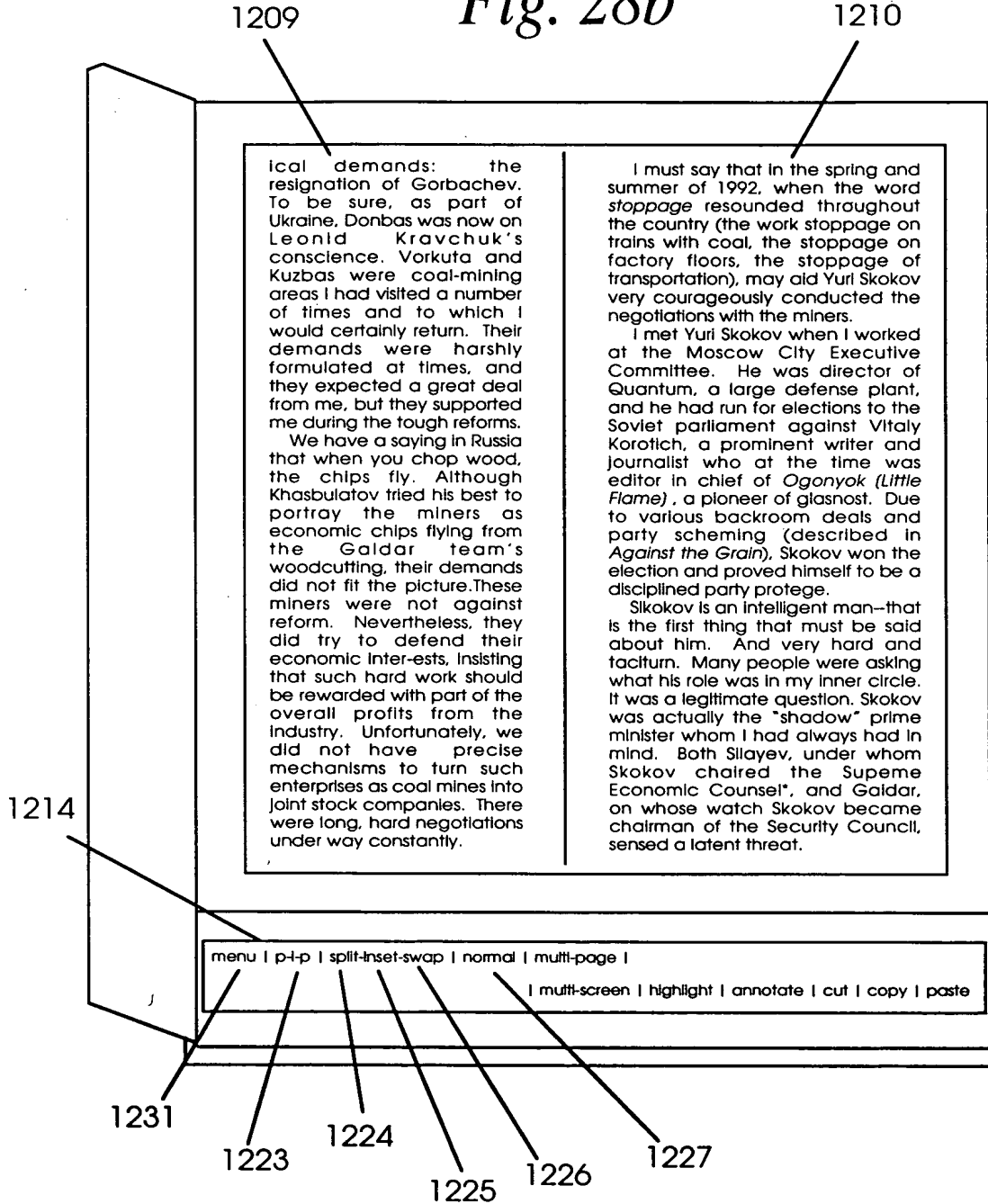

Fig. 28c

1207'

1208'

ical demands: the resignation of Gorbachev. To be sure, as part of Ukraine, Donbas was now on Leonid Kravchuk's conscience. Vorkuta and Kuzbas were coal-mining areas I had visited a number of times and to which I would certainly return. Their demands were harshly formulated at times, and they expected a great deal from me, but they supported me during the tough reforms.



We have a saying in Russia that when you chop wood, the chips fly. Although Khasbulatov tried his best to portray the miners as economic chips flying from the Gaidar team's woodcutting, their demands did not fit the picture. These miners were not against reform. Nevertheless, they did try to defend their economic inter-ests, insisting that such hard work should be rewarded with part of the overall profits from the industry. Unfortunately, we did not have precise mechanisms to turn such enterprises as coal mines into joint stock companies. There were long, hard negotiations under way constantly.

I must say that in the spring and summer of 1992, when the word *stoppage* resounded throughout the country (the work stoppage on trains with coal, the stoppage on factory floors, the stoppage of transportation), may aid Yuri Skokov very courageously conducted the negotiations with the miners.

I met Yuri Skokov when I worked at the Moscow City Executive Committee. He was director of Quantum, a large defense plant, and he had run for elections to the Soviet parliament against Vitaly Korotich, a prominent writer and journalist who at the time was editor in chief of *Ogonyok (Little Flame)*, a pioneer of glasnost. Due to various backroom deals and party scheming (described in *Against the Grain*), Skokov won the election and proved himself to be a disciplined party protege.

Skokov is an intelligent man--that is the first thing that must be said about him. And very hard and taciturn. Many people were asking what his role was in my inner circle. It was a legitimate question. Skokov was actually the "shadow" prime minister whom I had always had in mind. Both Silayev, under whom Skokov chaired the Supreme Economic Counsel, and Gaidar, on whose watch Skokov became chairman of the Security Council, sensed a latent threat.

1214

menu | p-t-p | split-inset-swap | normal | multi-page |
 | multi-screen | highlight | annotate | cut | copy | paste

1231

1223

1224

1225

1226

1227

09335588 061799

APPROVED	O.G. FIG.	
BY	CLASS	SUBCLASS
DRAFTSMAN		

66290" B92EE60

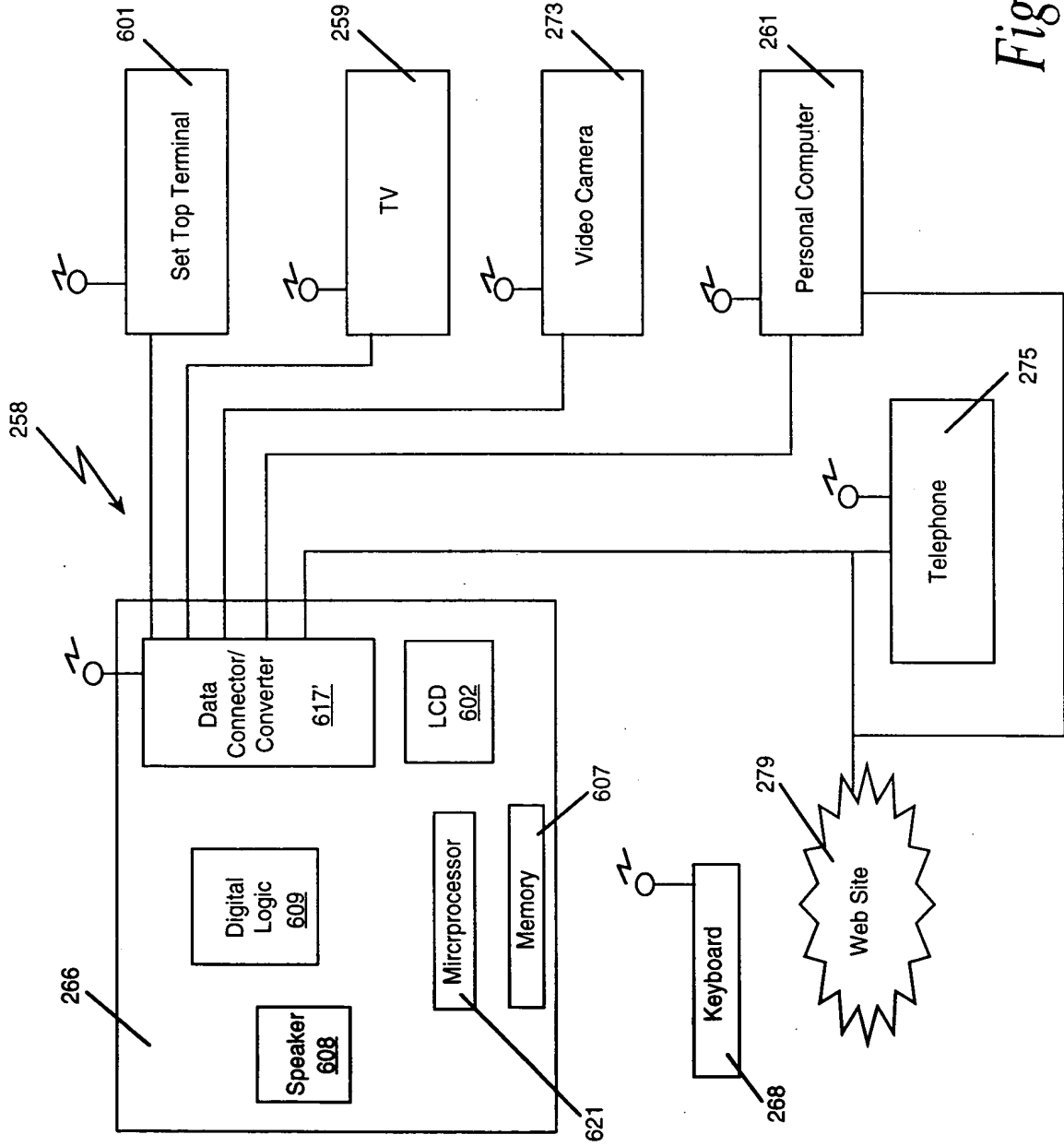

Fig. 29a

47
—
47

Fig. 29b

662793" 89255660

